

The background of the advertisement features a close-up, angled view of a door's edge, showing a dark wood-grain finish on the left and a grey, textured composite material on the right. A silver handle is visible on the right side. In the lower-left corner, a smaller image shows a wooden door with a silver, semi-circular decorative element and a silver handle.

# **VIKKING**

*composite doors*

Beautiful, warm, safe  
- your door of dreams

**CATALOG 2015**

## Table of Contents

---

	The advantage of the system	3
<hr/>		
<b>Exclusive Group - ARCTIC Plus / ARCTIC / PREMIUM lines</b>		7
	Diplomat Collection	10
	Classic Collection	30
	Inspirations / custom solutions	36
<b>Optimal Group - OPTIMAL / INTERIOR lines</b>		44
	Diplomat Collection	46
	Classic Collection	54
<hr/>		
<b>Technical Information</b>		58
	Colors	58
	Stained-glass windows	59
	Standard dimensions of doors	60
	Opening directions	61
	Sidelights variants	62
	Application variants of decorations and units	63
<hr/>		
<b>Equipment</b>		64
	BioKey	64
	Locks	65
	Locking plates	65
	Hinges	65
	Handles	66
	Pull handles	67
	Accessories	67
<hr/>		
<b>Compendium of knowledge</b>		68
	Assembly	69
	Utilization	71
	Guarantees	73
<hr/>		
<b>PRICE LIST 2015</b>		74
	Doors	C2
	Custom realizations	C11
	Handles / Pull handles	C12
	Additional equipment	C13

## PERFECT PROTECTION OF YOUR HOME



- ✓ effectively protect against the heat loss - **Ud factor from 0,63 W/m<sup>2</sup>K**,
- ✓ Doors of ARCTIC Plus, ARCTIC, PREMIUM and OPTIMAL lines are standard equipped with multi-point anti-burglary strip locks,
- ✓ excellent resistance to vandalism and burglary - **RC II class** according to the standard (PN-EN 1627:2011),
- ✓ protects against the noise of busy street,
- ✓ excellent test results carried out by the notified laboratories allow to turnover in the European Union.

## TAILOR-MADE



- ✓ unlimited selection of models, sizes, colors and unique stained-glass decorations from own studio,
- ✓ a wide range of top quality fittings and door accessories,
- ✓ doors adapted to custom building openings
- ✓ double doors,
- ✓ sidelights in various sizes and shapes,
- ✓ only in composite doors resistant to moisture PVC door frames with extensions system, connectors and sidelights in any configuration,
- ✓ on request frames from the highest quality meranti wood,
- ✓ rebate or non-rebated doors, opening to the outside or inside.

## UNIQUE



- ✓ by using to production composite materials with unreachable for traditional materials parameters - we set new trends in the quality and design of the front door,
- ✓ VIKKING composite doors are manufactured using advanced technologies that are protected by the international patents,
- ✓ innovative structural pasting of glass units, provides a stability of doors, safety and protection against loss of energy,
- ✓ composite doors with SMOOTH surface, or in its unique combination
- ✓ with the structure of the grain wood - Real Wood in any configuration and color,
- ✓ innovative stained glass in unlimited design, hand-created in own studio by the best craftsmen,
- ✓ flexibility of combining colors in unlimited scope completes the uniqueness of composite doors VIKKING.

## FUNCTIONAL



- ✓ maintenance of door kept to a minimum and is not complicated,
- ✓ paint coatings don't require periodic maintenance,
- ✓ specially developed, six-chamber PVC door frames Class A Plus have a unique surface of precious wood, in contrast to which they are completely resistant to moisture
- ✓ and don't require maintenance,
- ✓ surfaces of composite sashes are resistant to damage,
- ✓ composite doors have the optimal price-advantage ratio,
- ✓ each order is individually produced by experienced professionals, for whom customer satisfaction is the highest recognition.

## SOLID



- ✓ composite doors have the aesthetics of wood, light weight of aluminium, resistance of steel and durability of PVC, are also free from defects associated to traditional materials,
- ✓ advanced technology, the highest quality components, fittings and coatings of renowned manufacturers provide many years of trouble-free operation,
- ✓ composite doors VIKKING are resistant to moisture and most difficult climatic conditions - composite sashes don't deform under the influence of weather conditions, we can guarantee their constant technical durability for decades.

## Construction of composite doors Vikking - 12 arguments for yes:

1. Innovative, six-chamber PVC door frame class A Plus with structured precious wood surface. PVC profiles are resistant to moisture, perfectly insulate from the cold and require no maintenance.
2. Composite sash with specially reinforced construction which prevents deformation, even in difficult weather conditions; resistant to moisture and mechanical damage. Only composite sashes keep consistently high quality for decades without the need of maintenance and painting.
3. Sash linings made from the highest quality composite panels resistant to scratches and damage.
4. Solid multi-layer construction provides stability of the sash and burglar protection.
5. Waterproof composite frame protects the interior of the sash from moisture.
6. CFC-free insulation provides excellent protection against the heat loss.
7. The highest quality coatings in any RAL colors or in one of the many wood grain decors combined with total resistance of composite doors to moisture makes them resistant in the extent of the reach of traditional materials.
8. Silicone seals designed specifically for composite doors, provide maximum protection against the heat loss around the perimeter and provide a pleasant sound when closing.
9. Low threshold with durable aluminium thermal barrier provides insulation from the external climate.
10. Heat-insulating subliminal profiles with warm assembly system provide a stable positioning of door eliminates thermal bridges and protects against moisture.
11. Specially designed and manufactured locking plates made of stainless steel provides full adjustment during the long-term usage.
12. System of multi-point locks and anti-theft blockades raises the level of burglary protection.

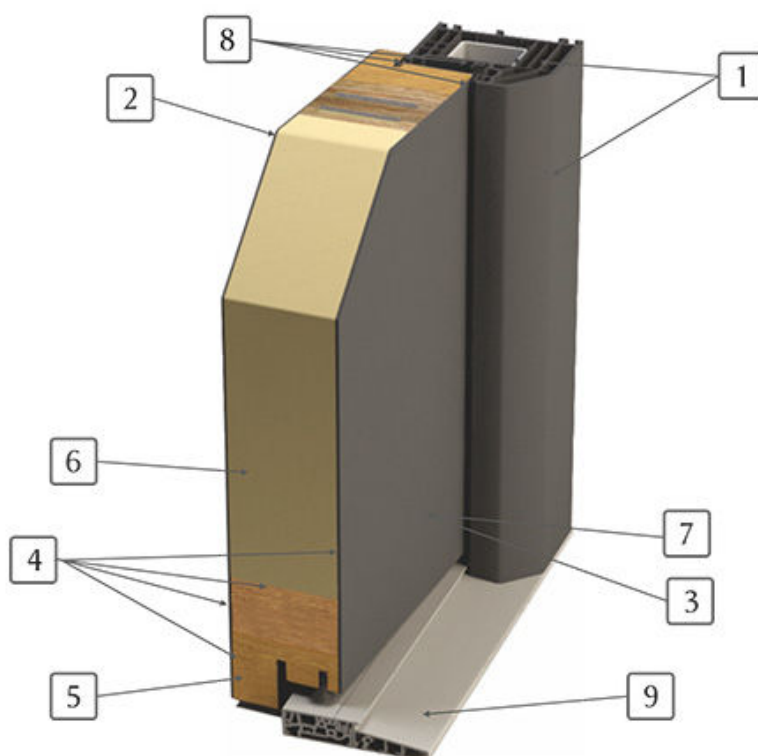

# Composite doors Vikking - we are limited only by your imagination

**SMOOTH surface**

**Static connector**

**RW surface**

**Three 3D adjustable hinges**

**Intelligent control**

**Security blockades**

**Deep crease**

**3D sash decoration**

**Decorative flush strip**

**Multipoint anti-burglary strip locks perfectly matched to your needs**

**Adjusted locking plates made of stainless steel**

**Door frame extension**

**Decorative finish strip**

**7** The beauty of precious wood

**7** A rainbow of colors from the threshold

**9** Low aluminum threshold with thermal barrier and subliminal profile

**8** Wind stop seal

**LED lighting**

**12**

***We constantly develop and improve production processes, so that you can decide on the final design and accessories of your door of dreams.***

# Why composite doors Vikking

**No longer you don't have to agree to compromises!**

Not all suppliers are able to meet the stringent requirements for the highest aesthetic of doors combined with the best protection of your home.

We have developed from the scratch innovative composite doors to meet your most demanding expectations.

Advanced technology and innovative solutions enable to make any door of your dreams without any concessions in quality and durability!

No other doors have as many advantages, without defects and limitations associated with traditional technologies, composite doors are resistant to adverse weather conditions, don't absorb the moisture, don't corrode and retain consistently high quality for decades.

For years, our motto is:

**"What for others is unusual - we treat it as a standard, what for others is impossible - we make it tomorrow".**

VIKKING from many years is specializing in the implementation of most custom orders.

Unleash your creativity from the threshold and start by changing the door.

Choose your style, any combination of colors and surface textures of doors, choose most convenient handles and beautiful stained glass windows, we will take care of the rest with the greatest reverence.

To ensure the transparency of our extremely rich offer, this publication will make it easy to choose the door by division them on lines, collections, models and equipment.

Five lines, two collections, number of models and stained glass designs limited by the imagination are undoubted advantages of the system of composite doors VIKKING.

## For your convenience - **NEW INFORMATION SYSTEM**



The product meets the requirements of the European Union



Sash thickness



Stainless steel finish strip



Coefficient of thermal insulation  
 $U_D = 0,63 \text{ W/m}^2\text{K}$



Rebate system



Stainless steel plinth strip (finish, height 90 mm)



Anti-burglar according to PN-EN 1627:2011



Non-rebated system



Stainless steel flush frame



The requirement of a full door roofing



Triple sealing system



Stainless steel finish frame



Guarantee of the technical efficiency of the composite sash



Quadruple glazing units



External composite frame



Sash surface Real Wood - grain wood



Super Spacer warm edge between the glass



Internal composite frame



Sash surface SMOOTH



Soundproofing



The system on both sides frameless



RAL colors



Milled surface decoration of the sash - one-sided



Decorative frame of the classic collection



Colors in wood grain decors



Stainless steel flush strip

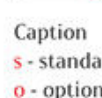

Caption  
s - standard  
o - option  
N/D - not applicable

## ARCTIC Plus line ★★★★★

Composite doors of ARCTIC Plus line - the quintessence of timeless design, excellent quality and legendary resistance to climatic conditions. These doors set new standards of energy losses reduction and conservancy of natural resources.

As the only one in its class - do not require door roofs!

You no longer need to be held hostage to the limitations identical to the traditional door!

Modern design combined with the perfection of form and the most beautiful stained glass decorations underline the uniqueness of ARCTIC Plus door.

Excellent protection against heat loss - and the most favorable price-quality ratio, make them unrivaled in the world elite group of passive door.

### Purpose:

- ✓ Exterior doors opening to the outside or inside,
- ✓ Dedicated to the zero-energy and passive buildings.

### Standard equipment:

- ✓ composite sash 68 mm from the DIPLOMAT collection in the rebate version of wood-like surface Real Wood structure, optional: with SMOOTH surface, or in any combination of both surfaces - see price list,
- ✓ PVC door frame 85 mm - NEW! made of six-chamber profile class A Plus of wood-like surface Real Wood structure or a SMOOTH surface, optional: door frame of the highest quality meranti wood 85mm x 75mm - see price list,
- ✓ door set finally painted with the highest quality lacquers in the full range of RAL colors or in one of the wood decors, optional: painting in several freely configurable colors according to the order - see price list,
- ✓ low aluminium threshold with thermal barrier, optional: with the system of insulating profiles - see price list,
- ✓ Four 3D adjustable hinges with increased resistance to burglary,
- ✓ anti-theft blockade system,
- ✓ three-point anti-theft strip lock, lockable by handle or automatic lock,
- ✓ a set of adjustable locking plates made of stainless steel
- ✓ triple sealing system around the edges,
- ✓ wind stop - seal in threshold part of the frame,
- ✓ in versions with glazing: quadruple glazing units with system of warm edge Super Spacer.

Optional: custom projects - see price list.

Dedicated fittings and equipment: see price list.



***By saving energy,  
we care about the future generations.***

## ARCTIC Line ★★★★★

ARCTIC line - doors designed for demanding customers and those, who appreciate quality. Top class fittings and equipment complement this unique offer of door with excellent aesthetic and functional parameters. Door in connection with the PVC door frame are completely resistant to moisture.

They do not require roofs to protect them from rain.  
Protection factor against heat loss –  $U_p$  from 0,81 W/m<sup>2</sup>K.

### Purpose:

- ✓ Exterior doors opening to the outside or inside,
- ✓ Perfect for energy-efficient or passive single-family homes.

### Standard equipment:

- ✓ composite sash 60 mm in the rebate version of wood-like surface Real Wood structure optional: with SMOOTH surface, or in any combination of both surfaces - see price list,
- ✓ PVC door frame 70 mm made of six-chamber profile class A of wood-like surface Real Wood structure or a SMOOTH surface, optional: door frame of the highest quality meranti wood 85mm x 75mm - see price list,
- ✓ door set finally painted with the highest quality lacquers in the full range of RAL colors or in one of the wood decors, optional: painting in several freely configurable colors according to the order - see price list,
- ✓ low aluminium threshold with thermal barrier, optional: with the system of insulating profiles - see price list,
- ✓ three 3D adjustable hinges with increased resistance to burglary,
- ✓ anti-theft blockade system,
- ✓ three-point anti-theft strip lock, lockable by handle or automatic lock,
- ✓ a set of adjustable locking plates made of stainless steel,
- ✓ double sealing system around the edges
- ✓ in versions with glazing: triple glazed units with system of warm edges Super Spacer.

Optional: custom projects - see price list.

Dedicated fittings and equipment: see price list.



## PREMIUM Line ★★★★★

Composite doors of PREMIUM line is the broadest offer for those, who seeking excellent quality products that will protect your home for many years. In addition to the numerous functional and technical advantages the doors of this line are distinguished by the widest range of available sizes, colors, glazings, fittings and equipment at no extra hidden costs.

Protection factor against heat loss –  $U_p$  from 0,85 W/m<sup>2</sup>K.

### Purpose:

- ✓ External or internal entrance doors, opening to the outside or inside,
- ✓ Perfect for energy-efficient houses.

### Standard equipment:

- ✓ composite sash 45 mm in the rebate version of wood-like surface Real Wood structure optional: with SMOOTH surface, or in any combination of both surfaces - see price list,
- ✓ PVC door frame 70 mm made of six-chamber profile class A of wood-like surface Real Wood structure or a SMOOTH surface, optional: door frame of the highest quality meranti wood 85mm x 65mm - see price list,
- ✓ door set finally painted with the highest quality lacquers in the full range of RAL colors or in one of the wood decors, optional: painting in several freely configurable colors according to the order - see price list,
- ✓ low aluminium threshold with thermal barrier, optional: with the system of insulating profiles - see price list,
- ✓ three 3D adjustable hinges with increased resistance to burglary,
- ✓ anti-theft blockade system,
- ✓ three-point anti-theft strip lock, lockable by handle, optional: automatic lock - see price list,
- ✓ a set of adjustable locking plates made of stainless steel,
- ✓ double sealing system around the edges,
- ✓ in versions with glazing: triple glazed units with system of warm edges Super Spacer.

Optional: custom projects - see price list.

Dedicated fittings and equipment: see price list.





NEW



Model: **DIPLOMAT 2D**

Color: **Dark Oak**

Sash surface: **RW**

Door handing: **Right to outside**

Lock: **3-point strip lock lockable by cylinder**

**- optional**

Hinges: **adjustable 3D** in color of fittings

Stained glass: **1.2-00-D/F/D**

Variant of application: **RZ+F**

Fittings: **pull handle P45B / handle Lord / rosette (color: F9)**



***Flush INOX frames  
- the essence of elegance***

RZ



**New!**  
**Size XXL**  
**now even**  
**1095 mm x 2210 mm**



**Electronic door viewer**  
**the guard of your home**



Model: **DIPLMAT 0i**  
Color: **Golden oak / RAL 9005**  
- optional  
Sash surface: **RW + SMOOTH**  
- optional  
Door handling: **Right to outside**  
Lock: **3-point strip lock lockable by handle**  
Hinges: **adjustable 3D** in color of fittings  
Variant of application: **F**  
Fittings: **handle Lord (F9)**



**SMOOTH**  
**S**

**Diplomat S**  
Color: **RAL 7047**  
Sash surface: **SMOOTH**  
Fittings: **handle Lord (F9)**



**SMOOTH**

**Diplomat 9**  
Color: **RAL 7038**  
Sash surface: **SMOOTH**  
Variant of application: **F**  
Fittings: **pull handle P45**  
**handle Lord / rosette (F9)**



**Diplomat 0B**  
Color: **RAL 7035**  
Sash surface: **RW**  
Variant of application: **F**  
Fittings: **handle Baron (F9)**



**Diplomat 0F**  
Color: **RAL 7003**  
Sash surface: **RW**  
Variant of application: **F**  
Fittings: **pull handle P45**  
**handle Lord / rosette (F9)**



**Diplomat 0G**  
Color: **RAL 7021**  
Sash surface: **RW**  
Variant of application: **FL**  
- optional  
Fittings: **pull handle Q45**  
**handle Baron / rosettes (F9)**



**Diplomat 0H**  
Color: **RAL 8001**  
Sash surface: **RW**  
Variant of application: **F**  
Fittings: **handle Lord (F9)**



Model: **DIPLOMAT 0N**  
 Sidelight: **variant II**  
 Color: **RAL 8023**  
 Sash surface: **RW**  
 Door handling: **Right to outside**  
 Lock: **3-point strip lock lockable by cylinder**  
 - optional  
 Hinges: **adjustable 3D** in color of fittings  
 Stained glass: **individual project**  
 Variant of application: **F**  
 Fittings: **pull handle P45 / handle Lord / rosette (F9)**



**Diplomat 0J**  
 Color: **RAL 7032**  
 Sash surface: **RW**  
 Variant of application: **F**  
 Fittings: **handle Baron (F9)**



**DIPLOMAT 0K**  
 Color: **RAL 7016**  
 Sash surface: **SMOOTH**  
 Variant of application: **F**  
 Fittings: **handle Lord (F9)**



**Diplomat 0L**  
 Color: **RAL 5014**  
 Sash surface: **RW**  
 Variant of application: **F**  
 Fittings: **handle Baron (F9)**



**Diplomat 0M**  
 Color: **RAL 7039**  
 Sash surface: **SMOOTH**  
 Variant of application: **F**  
 Fittings: **handle Baron (F9)**



**Diplomat 0P**  
 Color: **RAL 7046**  
 Sash surface: **SMOOTH**  
 Variant of application: **F**  
 Fittings: **handle Baron (F9)**



**Model: DIPLOMAT 20**  
 Color: **Walnut**  
 Sash surface: **RW**  
 Door handling: **Left to outside**  
 Lock: **3-point strip lock** lockable by door handle  
 Hinges: **adjustable 3D** in color of fittings  
 Stained glass: **3.1-24-T/D/T**  
 Variant of application: **RN**  
 Fittings: **handle Baron** (F9)



**Diplomat 21**  
 Color: **RAL 9016**  
 Sash surface: **RW**  
 Stained glass: **1.2-00-D/T/D**  
 Variant of application: **RN+LC**  
**(LC - optional)**  
 Fittings: **pull handle P45B**  
**handle Lord / rosette** (F9)



**Diplomat 28**  
 Color: **RAL 9006**  
 Sash surface: **SMOOTH**  
 Stained glass: **3.1-100-D/T/D**  
 Variant of application: **RN**  
 Fittings: **pull handle P45B**  
**handle Lord / rosette** (F9)



**Diplomat 2A**  
 Color: **Orzech**  
 Sash surface: **RW**  
 Stained glass: **1.2-00-D/T/D**  
 Variant of application: **RN**  
 Fittings: **handle Lord** (F9)



**Diplomat 2D**  
 Color: **Giemny orzech**  
 Sash surface: **RW**  
 Stained glass: **1.2-00-D/T/D**  
 Variant of application: **RZ+F**  
 Fittings: **pull handle P45B**  
**handle Lord / rosette** (F9)



**Diplomat 2E**  
 Color: **Golden oak / RAL 7000**  
**- optional**  
 Sash surface: **RW + SMOOTH**  
**- optional**  
 Stained glass: **3.1-122-D/T/D**  
 Variant of application: **RZ+F**  
 Fittings: **handle Baron** (F9)

## Dedicated stained glass

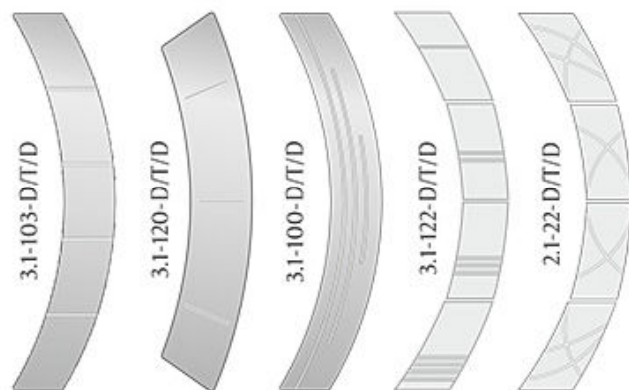

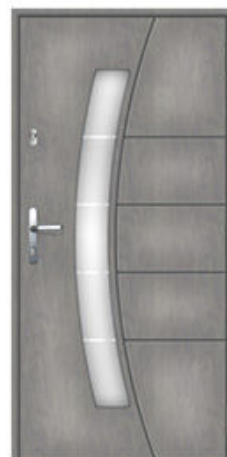

**Diplomat 2H**  
 Color: RAL 7036  
 Sash surface: RW  
 Stained glass: 3.1-103-D/T/D  
 Variant of application: KW+F  
 Fittings: handle Baron/rosettes (F9)

Model: **DIPLOMAT 30**  
 Color: RAL 3003/9016  
 - optional  
 Sash surface: RW  
 Door handling: Left to outside  
 Lock: 3-point strip lock lockable by door handle  
 Hinges: adjustable 3D in color of fittings  
 Stained glass: 3.2-77-T/D/T  
 Variant of application: RN  
 Fittings: handle Baron (F9)



**Diplomat 2i**  
 Color: RAL 3003/9016  
 - optional  
 Sash surface: SMOOTH  
 Stained glass: 3.2-77-T/D/T  
 Variant of application: KW+F  
 Hinges: handle Baron (F9)

Dedicated stained glass

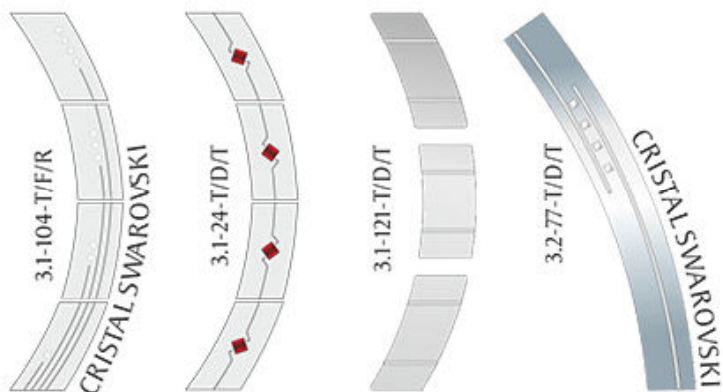

**Diplomat 2F**  
 Color: RAL 8001  
 Sash surface: RW  
 Stained glass: 3.1-121-D/T/D  
 Variant of application: RZ+FL+F  
 Fittings: pull handle P45B  
 handle Lord / rosette (F9)



**Diplomat 2G**  
 Color: RAL 5010  
 Sash surface: SMOOTH  
 Stained glass: 3.1-120-D/T/D  
 Variant of application: KW+FL+F  
 Fittings: handle Baron/rosettes (F9)

Presented in the catalog images show only a small part of our offer. In each model of composite doors, you can choose any color, equipment and stained glass designs, which the full range can be found on [www.vikking.eu](http://www.vikking.eu)



**Diplomat 4W**  
 Color: RAL 5023/RAL 5011  
 - optional  
 Sash surface: SMOOTH  
 Stained glass: 6.1-105-T/D/T  
 Variant of application: KW+F  
 Fittings: handle Baron (F9)

Model: **DIPLOMAT 1D**  
 Color: Winchester / RAL 7016  
 Sash surface: RW + SMOOTH  
 - optional  
 Door handling: Right to outside  
 Lock: 3-point strip lock lockable by cylinder  
 - optional  
 Elektric door strike - optional  
 Hinges: adjustable 3D in color of fittings  
 Stained glass: 2.2-07-F/D/F  
 Variant of application: KW+FL  
 - optional  
 Fittings: pull handle Q45 / handle Baron / rosette (color F9)



**Diplomat 4X**  
 Color: Walnut  
 Sash surface: RW  
 Stained glass: 3.1-128-D/T/D  
 Variant of application: KW+F  
 Fittings: handle Baron (F9)



**Diplomat 4Y**  
 Color: RAL 5023  
 Sash surface: SMOOTH  
 Stained glass: 6.1-114-T/F/R  
 Variant of application: KW+F  
 Fittings: handle Baron (F9)



**Diplomat 4Z**  
 Color: RAL 7040  
 Sash surface: RW  
 Stained glass: 3.1-119-D/T/D  
 Variant of application: KW  
 Fittings: pull handle P45  
 handle Lord / rosette (F9)



**Diplomat 5C**  
 Color: RAL 9016  
 Sash surface: SMOOTH  
 Stained glass: 3.1-128-D/T/D  
 Variant of application: KW+F  
 Fittings: pull handle P45  
 handle Lord / rosette (F9)



**Diplomat 5D**  
 Color: Złoty dąb/RAL 7016  
 - optional  
 Sash surface: RW+SMOOTH  
 - optional  
 Stained glass: 3.1-128-D/T/D  
 Variant of application: KW+F  
 Fittings: pull handle P45  
 handle Baron / rosette (F9)



Model: **DIPLOMAT 14**  
 Color: RAL 7021  
 Sash surface: RW  
 Door handling: Left to outside  
 Lock: 3-point strip lock lockable by handle  
 Hinges: adjustable 3D in color of fittings  
 Stained glass: 3.1-35-D/T/D  
 Variant of application: KW+PL  
 Fittings: handle Lord (color F9)



**Diplomat 5G**  
 Color: RAL 6022  
 Sash surface: RW  
 Stained glass: 3.1-35-D/T/D  
 Variant of application: KW+F  
 Fittings: pull handle P45  
 handle Baron / rosette (F9)



**Diplomat 5E**  
 Color: RAL 5014  
 Sash surface: SMOOTH  
 Stained glass: 1.2-00-D/F/D  
 Variant of application: KW+F  
 Fittings: pull handle P45  
 handle Baron / rosettes (F9)

Dedicated stained glass

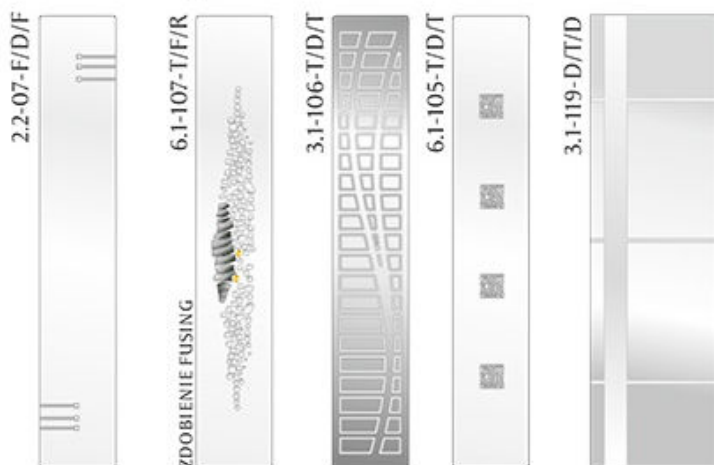

**Diplomat 5i**  
 Color: RAL 7036  
 Sash surface: SMOOTH  
 Stained glass: 1.2-00-D/F/D  
 Variant of application: ZW+F  
 Fittings: pull handle P45  
 handle Baron / rosette (F9)



**Diplomat 5j**  
 Color: RAL 7036  
 Sash surface: SMOOTH  
 Stained glass: 1.2-00-D/F/D  
 Variant of application: ZW+F  
 Fittings: pull handle P45  
 handle Baron / rosette (F9)

Presented in the catalog images show only a small part of our offer. In each model of composite doors, you can choose any color, equipment and stained glass designs, which the full range can be found on [www.vikking.eu](http://www.vikking.eu)



**Diplomat 42**  
 Color: RAL 9016  
 Sash surface: RW  
 Stained glass: 1.2-00-D/F/D  
 Variant of application: RN  
 Fittings: handle Lord (white)

Model: **DIPLMAT 4U**  
 Color: RAL 9007  
 Sash surface: SMOOTH  
 Door handling: Left to outside  
 Lock: 3-point strip lock lockable by handle  
 Hinges: adjustable 3D in color of fittings  
 Stained glass: 3.1-35-D/T/D  
 Variant of application: RN  
 Fittings: handle Lord (color: F9)



**Diplomat 43**  
 Color: RAL 7016  
 Sash surface: RW  
 Stained glass: 3.1-126-T/D/T  
 Variant of application: RN  
 Fittings: handle Lord (F9)



**Diplomat 45**  
 Color: Orzech  
 Sash surface: RW  
 Stained glass: 1.2-00-D/F/D  
 Variant of application: RN  
 Fittings: handle Lord (F9)



**Diplomat 46**  
 Color: Włoski orzech  
 Sash surface: RW  
 Stained glass: 3.1-112-T/D/T  
 Variant of application: RN  
 Fittings: handle Baron (F9)



**Diplomat 48**  
 Color: RAL 7035  
 Sash surface: SMOOTH  
 Stained glass: 1.2-00-D/F/D  
 Variant of application: RN  
 Fittings: handle Baron (F9)



**Diplomat 5H**  
 Color: RAL 7044  
 Sash surface: SMOOTH  
 Stained glass: 3.1-106-T/D/T  
 Variant of application: KW+F  
 Fittings: handle Baron (F9)





**Diplomat 4i**  
 Color: **Gemny orzech**  
 Sash surface: RW  
 Stained glass: 3.1-35-D/T/D  
 Variant of application: RN  
 Fittings: handle Baron

**Model: DIPLOMAT 4S**

Color: RAL 7021  
 Sash surface: RW  
 Door handling: Right to outside  
 Lock: 3-point strip lock lockable by cylinder  
 -optional  
 Mechanical locking plate - optional  
 Hinges: adjustable 3D in color of fittings  
 Stained glass: 1.2-00-D/T/D  
 Variant of application: RN  
 Fittings: pull handle Q45 / handle Lord / rosette (color: F9)



**Diplomat 4J**  
 Color: RAL 7021  
 Sash surface: RW  
 Stained glass: 1.2-00-D/T/D  
 Variant of application: RN  
 Fittings: handle Lord (F9)

**Dedicated stained glass**

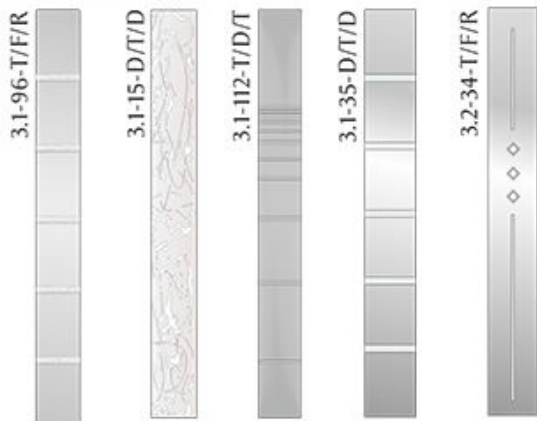

**Diplomat 4H**  
 Color: **Włoski orzech**  
 Sash surface: RW  
 Stained glass: 3.1-96-T/F/R  
 Variant of application: RN  
 Fittings: handle Lord (F9)



**Diplomat 4K**  
 Color: RAL 7016  
 Sash surface: SMOOTH  
 Stained glass: 1.2-00-D/T/D  
 Variant of application: RN  
 Fittings: handle Lord (F9)

Presented in the catalog images show only a small part of our offer. In each model of composite doors, you can choose any color, equipment and stained glass designs, which the full range can be found on [www.vikking.eu](http://www.vikking.eu)



**Model: DIPLOMAT 4M**  
 Color: **Orzech**  
 Sash surface: **RW**  
 Stained glass: **3.1-128-D/T/D**  
 Door handling: **Left to outside**  
 Lock: **3-point strip lock** lockable by handle  
 Hinges: **adjustable 3D** in color of fittings  
 Variant of application: **RN**  
 Fittings: **handle Baron (F9)**



**Diplomat 4N**  
 Color: **RAL 7016**  
 Sash surface: **RW**  
 Stained glass: **1.2-00-D/T/D**  
 Variant of application: **RN**  
 Fittings: **handle Baron (F9)**



**Diplomat 4P**  
 Color: **RAL 7016**  
 Sash surface: **RW**  
 Stained glass: **1.2-00-D/T/D**  
 Variant of application: **RN**  
 Fittings: **pull handle Q45**  
**handle Baron / rosette (F9)**



**Diplomat 4R**  
 Color: **RAL 9004**  
 Sash surface: **RW**  
 Stained glass: **3.2-34-T/F/R**  
 Variant of application: **RN**  
 Fittings: **handle Baron (F9)**

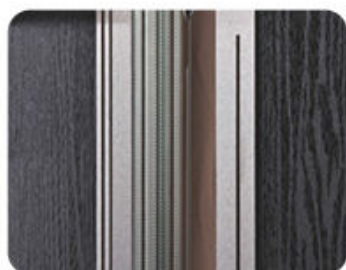

**Diplomat 4T**  
 Color: **RAL 7040**  
 Sash surface: **RW**  
 Stained glass: **3.1-125-T/D/T**  
 Variant of application: **RN**  
 Fittings: **handle Baron (F9)**





**Diplomat 4V**  
 Color: RAL 8017  
 Sash surface: SMOOTH  
 Stained glass: 3.1-127-D/T/D  
 Variant of application: RZ+F  
 Fittings: handle Lord (F9)

Model: **DIPLOMAT 58**  
 Color: Italian walnut  
 Sash surface: RW  
 Stained glass: 3.1-126-T/D/T  
 Door handling: Left to outside  
 Lock: 3-point strip lock lockable by handle  
 Hinges: adjustable 3D in color of fittings  
 Variant of application: KZ  
 Fittings: handle Lord (color: F9)



**Diplomat 5F**  
 Color: Golden oak  
 Sash surface: RW  
 Stained glass: 1.2-00-D/T/D  
 Variant of application: RN  
 Fittings: handle Baron (F9)

Dedicated stained glass

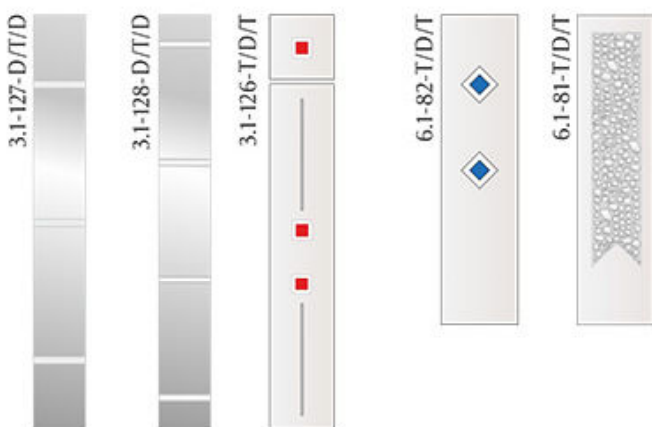

**Diplomat 81**  
 Color: RAL 9011  
 Sash surface: RW  
 Stained glass: 6.1-82-T/D/T  
 Variant of application: RN + LC  
 Fittings: handle Baron (F9)

Presented in the catalog images show only a small part of our offer. In each model of composite doors, you can choose any color, equipment and stained glass designs, which the full range can be found on [www.vikking.eu](http://www.vikking.eu)



## DIPLOMAT 1H

Color: RAL 3003/7040

- optional

Sash surface: SMOOTH

Door handling: Right to outside

Lock: 3-point strip lock lockable by cylinder

- optional

Hinges: adjustable 3D in color of fittings

Stained glass: 3.1-12-T/D/T

Variant of application: KW + F

Fittings: pull handle Q45 / handle Baron / rosette (color: F9)



## Diplomat 11

Color: Walnut

Sash surface: RW

Stained glass: 4.1-29-T/F/R

Variant of application: KW

Fittings: handle Lord (F9)

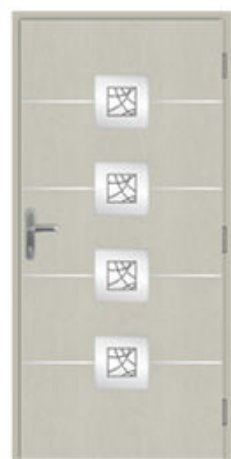

## Diplomat 1C

Color: RAL 7044

Sash surface: RW

Stained glass: 2.1-10-D/T/D

Variant of application: KW+FL

- optional

Fittings: handle Baron (F9)



## Diplomat 1i

Color: RAL 7021/3003

- optional

Sash surface: RW

Stained glass: 2.1-09-D/T/D

Variant of application: KW+F

Fittings: handle Baron (F9)



## Diplomat 1j

Color: RAL 7036

Sash surface: SMOOTH

Stained glass: 6.1-108-T/D/T

Variant of application: KW+F

Fittings: handle Baron (F9)



## Diplomat 1K

Color: RAL 9017

Sash surface: SMOOTH

Stained glass: 6.1-11-T/D/T

Variant of application: KW+F

Fittings: handle Baron (F9)



## Diplomat 1L

Color: RAL 7040

Sash surface: SMOOTH

Stained glass: 2.1-09-D/T/D

Variant of application: KW+F

Fittings: handle Baron (F9)



## Diplomat 40

Color: RAL 7026

Sash surface: RW

Stained glass: 6.1-11-T/D/T

Variant of application: RN+LC

(LC - optional)

Fittings: pull handle P45

handle Lord / rosette (F9)

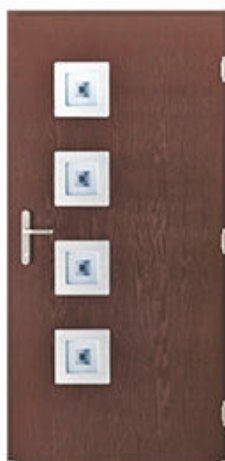

**Diplomat 4A**  
Color: Walnut  
Sash surface: RW  
Stained glass: 6.1-11-T/D/T  
Variant of application: RN  
Fittings: handle Baron (F9)



**Diplomat 4B**  
Color: RAL 7024  
Sash surface: RW  
Stained glass: 6.1-11-T/D/T  
Variant of application: RN  
Fittings: handle Baron (F9)



**Diplomat 4C**  
Color: Walnut  
Sash surface: RW  
Stained glass: 4.1-29-T/F/R  
Variant of application: RN  
Fittings: handle Lord (F9)



**Diplomat 4D**  
Color: RAL 5001  
Sash surface: RW  
Stained glass: 3.1-124-T/D/T  
Variant of application: RN  
Fittings: handle Baron (F9)



**Diplomat 4E**  
Color: RAL 7040  
Sash surface: RW  
Stained glass: 4.1-29-T/F/R  
Variant of application: RN  
Fittings: handle Lord (F9)



**Diplomat 4F**  
Color: RAL 7024  
Sash surface: RW  
Stained glass: 6.1-11-T/D/T  
Variant of application: RN  
Fittings: handle Baron (F9)



**Diplomat 4G**  
Color: RAL 7043  
Sash surface: RW  
Stained glass: 2.2-27-F/L/F  
Variant of application: RN  
Fittings: handle Baron (F9)



**Diplomat 56**  
Color: RAL 8028  
Sash surface: SMOOTH  
Stained glass: 6.1-11-T/D/T  
Variant of application: KW+F  
Fittings: handle Baron (F9)



**Diplomat 57**  
Kolor: RAL 7005  
Powierzchnia: SMOOTH  
Witraż: 3.1-12-T/D/T  
Wariant aplikacji: KW+F  
Okucia: pochwyt P45  
klamka Baron / rozetki (F9)



**Diplomat 80**  
Kolor: Mahoń  
Powierzchnia: RW  
Witraż: 6.1-67-T/F/R  
Wariant aplikacji: RN  
Okucia: pochwyt P45  
klamka Lord / rozetka (F9)

Dedicated stained glass



Presented in the catalog images show only a small part of our offer.  
In each model of composite doors, you can choose any color,  
equipment and stained glass designs, which the full range can be found on [www.vikking.eu](http://www.vikking.eu)



## DIPLOMAT 26

Color: **Golden oak**  
 Sash surface: **RW**  
 Door handling: **Left to outside**  
 Lock: **3-point strip lock** lockable by handle  
 Hinges: **adjustable 3D** in color of fittings  
 Stained glass: **2.3-20-T/D/T**  
 Variant of application: **RN**  
 Fittings: **handle Lord** (color: F9)



## Diplomat 1A

Color: **9016/9006**  
 Sash surface: **SMOOTH**  
 Stained glass: **5.1-III-T/D/T**  
 Variant of application: **KW+PL**  
 Fittings: **pull handle P45**  
**handle Baron / rosette** (F9)



## Diplomat 41

Color: **RAL 7021**  
 Sash surface: **RW**  
 Stained glass: **3.2-42-T/F/R**  
 Variant of application: **RN**  
 Fittings: **handle Baron** (F9)



## Diplomat 44

Color: **Golden oak**  
 Sash surface: **RW**  
 Stained glass: **2.2-95-T/D/T**  
 Variant of application: **RN**  
 Fittings: **handle Lord** (F9)



## Diplomat 50

Color: **RAL 9004**  
 Sash surface: **RW**  
 Stained glass: **2.2-95-T/D/T**  
 Variant of application: **RN**  
 Fittings: **handle Baron** (F9)



## Diplomat 51

Color: **RAL 5014**  
 Sash surface: **RW**  
 Stained glass: **1.2-00-D/T/D**  
 Variant of application: **RN**  
 Fittings: **pull handle P45**  
**handle Baron / rosette** (F9)



## Diplomat 52

Color: **RAL 7000**  
 Sash surface: **RW**  
 Stained glass: **3.1-41-D/T/D**  
 Variant of application: **RZ+F**  
 Fittings: **handle Lord** (F9)



## Diplomat 53

Color: **Golden oak**  
 Sash surface: **RW**  
 Stained glass: **1.2-00-D/T/D**  
 Variant of application: **KW+F**  
 Fittings: **pull handle P45**  
**handle Baron / rosettes** (F9)



**DIPLOMAT 5B**

Color: RAL 7021  
 Sash surface: RW  
 Door handling: Left to outside  
 Lock: 3-point strip lock lockable by handle  
 Hinges: adjustable 3D in color of fittings  
 Stained glass: 1.2-00-D/T/D  
 Variant of application: RN  
 Fittings: handle Lord (F9)



**Diplomat 54**

Color: RAL 7036  
 Sash surface: RW  
 Stained glass: 3.1-117-T/D/T  
 Variant of application: KW+F  
 Fittings: handle Baron (F9)

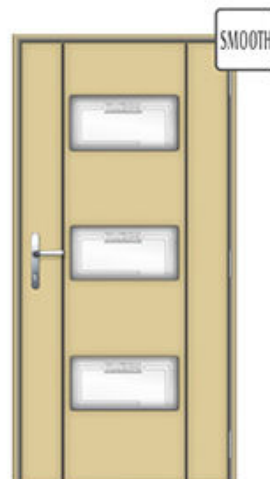

**Diplomat 55**

Color: RAL 1000  
 Sash surface: SMOOTH  
 Stained glass: 5.1-110-T/D/T  
 Variant of application: KW+F  
 Fittings: handle Baron (F9)

**Dedicated stained glass**

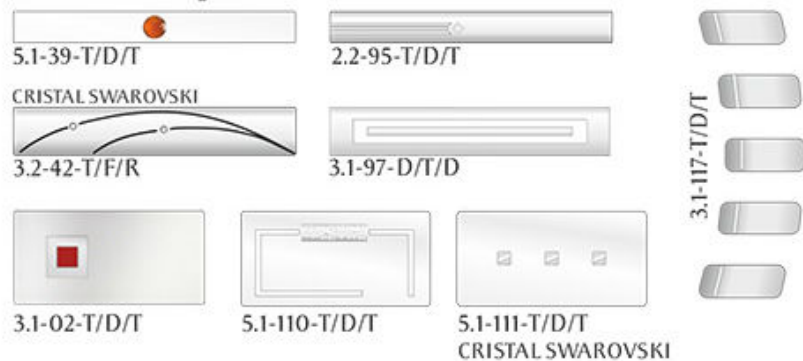

**Diplomat 5A**

Color: RAL 7040  
 Sash surface: RW  
 Stained glass: 1.2-00-D/T/D  
 Variant of application: RN  
 Fittings: pull handle P45  
 handle Baron / rosette (F9)

Presented in the catalog images show only a small part of our offer. In each model of composite doors, you can choose any color, equipment and stained glass designs, which the full range can be found on [www.vikking.eu](http://www.vikking.eu)



**Diplomat 60**  
Color: RAL 7024  
Sash surface: RW  
Stained glass: 1.2-00-D/T/D  
Variant of application: RN  
Fittings: pull handle P45  
handle Lord / rosette (F9)

**DIPLOMAT 6C**

Color: RAL 7021  
Sash surface: RW  
Door handling: Right to outside  
Lock: 4-point strip lock lockable by cylinder  
- optional  
Hinges: adjustable 3D in color of fittings  
Stained glass: 3.1-129-D/T/D  
Variant of application: RN+F  
Fittings: handle Lord / rosettes (color: F9)



**Diplomat 61**  
Color: RAL 7015  
Sash surface: RW  
Stained glass: 3.2-50-T/D/T  
Variant of application: RN  
Fittings: handle Baron (F9)



**Diplomat 63**  
Color: RAL 3018  
Sash surface: RW  
Stained glass: 1.2-00-D/T/D  
Variant of application: RN  
Fittings: handle Baron (F9)



**Diplomat 66**  
Color: RAL 7004/7011  
- optional  
Sash surface: RW  
Stained glass: 3.2-94-T/D/T  
Variant of application: RN  
Fittings: pull handle P45  
handle Lord / rosette (F9)



**Diplomat 6D**  
Color: RAL 8001  
Sash surface: RW  
Stained glass: 1.2-00-D/T/D  
Variant of application: RN  
Fittings: handle Baron (F9)

**Dedicated stained glass**

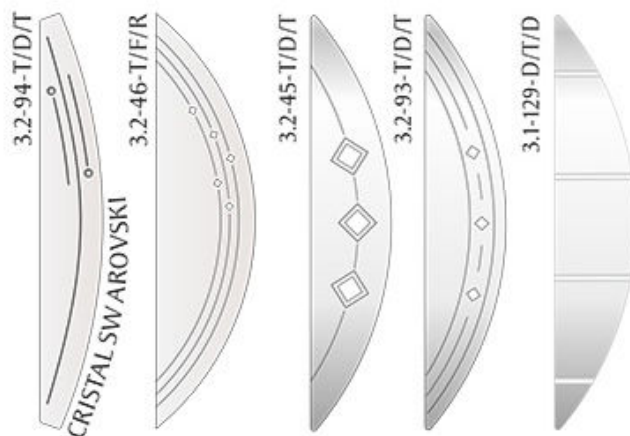





**Diplomat 75**  
 Color: RAL 7043  
 Sash surface: RW  
 Stained glass: 3.1-64-D/T/D  
 Variant of application: RN  
 Fittings: pull handle P45  
 handle Lord / rosette (F9)

**DIPLOMAT 6A**

Color: RAL 7004  
 Sash surface: RW  
 Door handling: Left to outside  
 Lock: 3-point strip lock lockable by handle  
 Hinges: adjustable 3D in color of fittings  
 Stained glass: 1.2-00-D/T/D  
 Variant of application: RN  
 Fittings: handle Lord (color: F9)



**Diplomat 79**  
 Color: RAL 7035  
 Sash surface: SMOOTH  
 Stained glass: 1.2-00-D/T/D  
 Variant of application: RN  
 Fittings: pull handle P45  
 handle Lord / plate (F9)

Dedicated stained glass

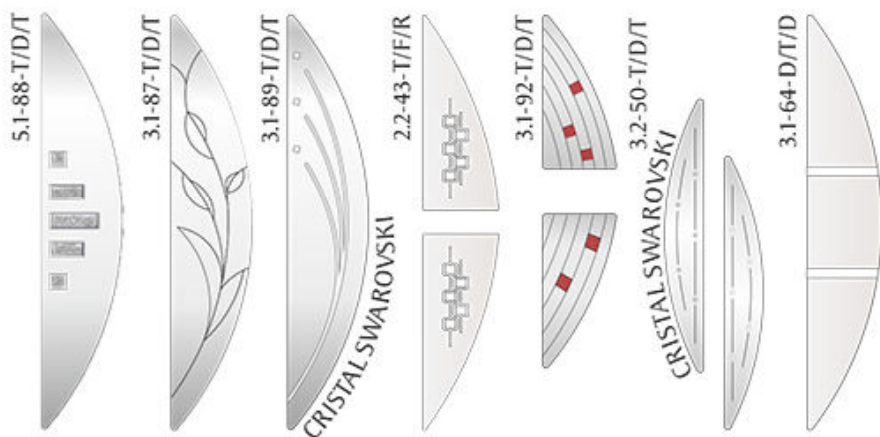

**Diplomat 6F**  
 Color: RAL 8017  
 Sash surface: RW  
 Stained glass: 3.1-92-T/D/T  
 Variant of application: RN  
 Fittings: handle Baron (F9)



**Diplomat 6G**  
 Color: RAL 8028  
 Sash surface: RW  
 Stained glass: 3.2-46-T/F/R  
 Variant of application: RN  
 Fittings: pull handle P45  
 handle Lord / rosette (F9)

Presented in the catalog images show only a small part of our offer. In each model of composite doors, you can choose any color, equipment and stained glass designs, which the full range can be found on [www.vikking.eu](http://www.vikking.eu)



Model: **DIPLOMAT 7F**  
 Color: **Italian walnut**  
 Sash surface: **RW**  
 Door handling: **Left to outside**  
 Lock: **3-point strip lock** lockable by handle  
 Hinges: **adjustable 3D** in color of fittings  
 Stained glass: **3.1-78-T/D/T**  
 Variant of application: **RN**  
 Fittings: **handle Baron** (color: F9)



**Diplomat 77**  
 Color: **RAL 8017**  
 Sash surface: **RW**  
 Stained glass: **3.1-56-D/T/D**  
 Variant of application: **RN**  
 Fittings: **pull handle P45**  
**handle Lord / rosette** (F9)



**Diplomat 7A**  
 Color: **RAL 7016**  
 Sash surface: **RW**  
 Stained glass: **3.2-58-T/D/T**  
 Variant of application: **RN**  
 Fittings: **handle Baron** (F9)



**Diplomat 7D**  
 Color: **RAL 6009**  
 Sash surface: **RW**  
 Stained glass: **3.2-58-T/D/T**  
 Variant of application: **RN**  
 Fittings: **pull handle P45**  
**handle Lord / rosette** (F9)



**Diplomat 7E**  
 Color: **Walnut**  
 Sash surface: **RW**  
 Stained glass: **1.2-00-D/T/D**  
 Variant of application: **RN**  
 Fittings: **handle Baron** (F9)



**Diplomat 7G**  
 Color: **RAL 7031/7035**  
 - optional  
 Sash surface: **SMOOTH**  
 Stained glass: **3.1-115-T/D/T**  
 Variant of application: **KW+F**  
 Fittings: **pull handle P45**  
**handle Lord / rosette** (F9)



**Diplomat 7H**  
 Color: **RAL 8007**  
 Sash surface: **SMOOTH**  
 Stained glass: **3.2-83-T/D/T**  
 Variant of application: **KW+F**  
 Fittings: **pull handle P45**  
**handle Lord / rosette** (F9)



RZ



**Diplomat 89**  
 Color: RAL 9004  
 Sash surface: RW  
 Stained glass: 3.1-56-D/T/D  
 Variant of application: RN  
 Fittings: pull handle P45  
 handle Lord / rosette (F9)

Model: **DIPLOMAT 88**  
 Color: Walnut  
 Sash surface: RW  
 Door handling: Left to outside  
 Lock: 3-point strip lock lockable by handle  
 Hinges: adjustable 3D in color of fittings  
 Stained glass: 3.2-57-T/D/T  
 Variant of application: RN  
 Fittings: handle Baron (F9)



SMOOTH

**Diplomat 7i**  
 Color: RAL 8003  
 Sash surface: SMOOTH  
 Stained glass: 3.2-57-T/D/T  
 Variant of application: RZ+F  
 Fittings: handle Baron (F9)

Dedicated stained glass

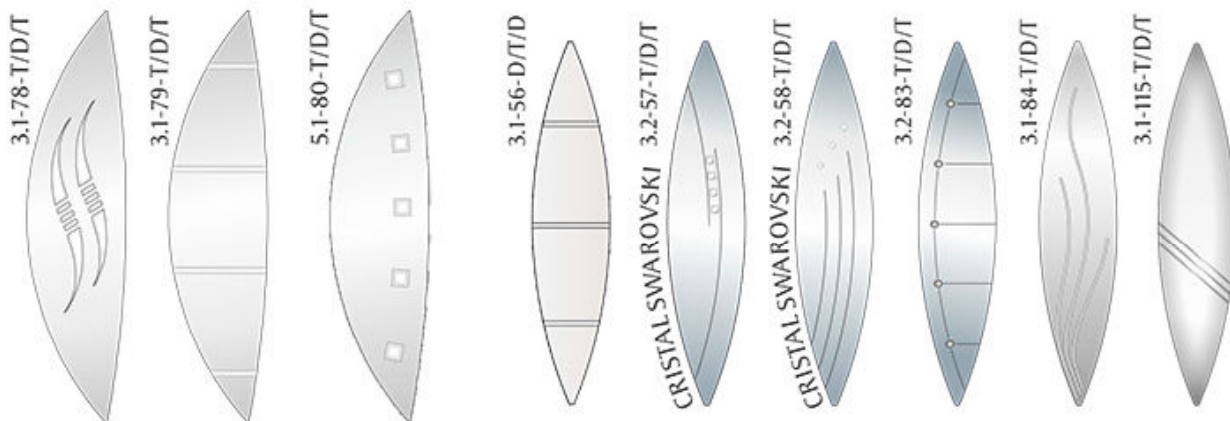

Presented in the catalog images show only a small part of our offer.  
 In each model of composite doors, you can choose any color,  
 equipment and stained glass designs, which the full range can be found on [www.vikking.eu](http://www.vikking.eu)



Model: **DIPLMAT 68**

Color: **RAL 9004 / Walnut**

- optional

Sash surface: **RW**

Door handling: **Right to outside**

Lock: **3-point strip lock lockable by cylinder**

- optional

Hinges: **adjustable 3D in color of fittings**

Stained glass: **3.2-53-T/F/R**

Variant of application: **RN**

Fittings: **pull handle Q45 / handle Baron / rosette (color: F9)**



**Diplomat 84**

Color: **Golden oak**

Sash surface: **RW**

Stained glass: **1.2-00-D/T/D**

Variant of application: **RN**

Fittings

**handle Lord / rosettes (F9)**



**Diplomat 8C**

Color: **RAL 9011/9006**

- optional

Sash surface: **SMOOTH**

Stained glass: **1.2-00-D/T/D**

Variant of application: **KW+F**

Fittings: **handle Baron (F9)**



**Diplomat 8D**

Color: **RAL 7036/9011**

- optional

Sash surface: **SMOOTH**

Stained glass: **3.1-116-D/T/D**

Variant of application: **KW+FL+F**

Fittings: **pull handle P45**

**handle Baron / rosette (F9)**

Dedicated stained glass

3.1-69-T/D/T



3.2-53-T/F/R



3.1-54-T/D/T

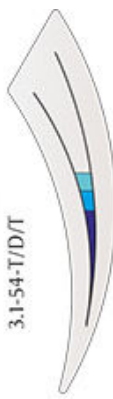

3.3-55-T/F/R



3.1-116-D/T/D





**Diplomat 73**  
 Kolor: Włoski orzech  
 Powierzchnia: RW  
 Witraż: 5.1-60-T/D/T  
 Wariant aplikacji: RN  
 Okucia:  
 klamka Lord / rozetki (F9)

Model: **DIPLOMAT 82**  
 Color: Walnut  
 Sash surface: RW  
 Door handling: Right to outside  
 Lock: 3-point strip lock lockable by handle  
 Hinges: adjustable 3D in color of fittings  
 Stained glass: 1.2-00-D/T/D  
 Variant of application: RN  
 Fittings: handle Baron (color: F9)



**Diplomat 85**  
 Color: RAL 7026  
 Sash surface: RW  
 Stained glass: 2.2-71-F/L/F  
 Variant of application: RN  
 Fittings: pull handle Q45  
 handle Baron / rosette (F9)

Dedicated stained glass

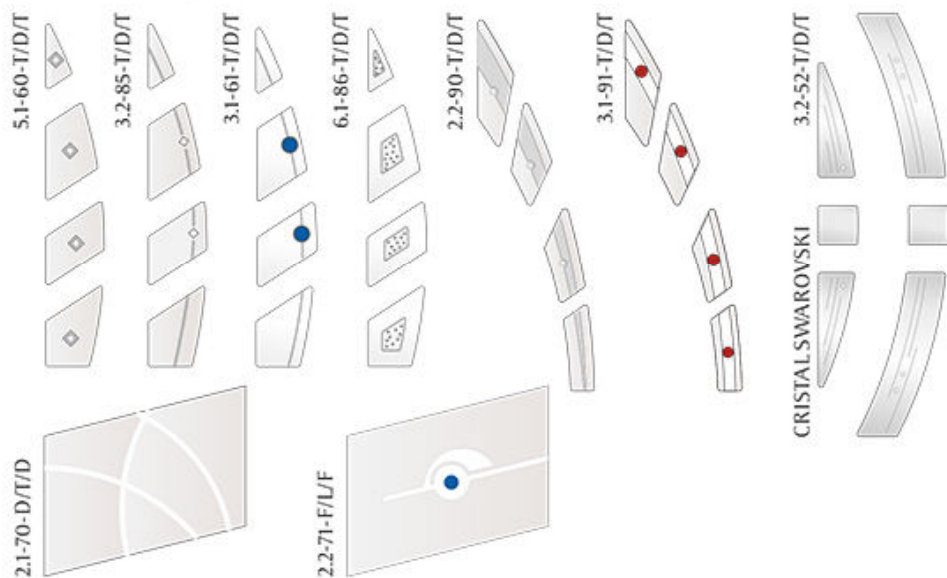

**Diplomat 67**  
 Color: RAL 7046  
 Sash surface: RW  
 Stained glass: 3.2-52-T/D/T  
 Variant of application: RN  
 Fittings: handle Baron (F9)

Presented in the catalog images show only a small part of our offer. In each model of composite doors, you can choose any color, equipment and stained glass designs, which the full range can be found on [www.vikking.eu](http://www.vikking.eu)



**Model: ATTACHE 14**

Color: **Walnut**  
 Sash surface: **RW**  
 Door handling: **Right to outside**  
 Lock: **3-point strip lock** lockable by handle  
 Hinges: **adjustable 3D** in color of fittings  
 Stained glass: **3.2-243-T/D/T**  
 Variant of application: **RR**  
 Fittings: **handle Baron** (color: F4)



**Attache 1**

Color: **Golden oak**  
 Sash surface: **RW**  
 Fittings: **handle Lord** (F3)



**Attache 2**

Color: **RAL 8017**  
 Sash surface: **RW**  
 Stained glass: **3.2-244-T/D/T**  
 Variant of application: **RR**  
 Fittings: **handle Lord** (F9)



**Attache 4**

Color: **Golden oak**  
 Sash surface: **RW**  
 Stained glass: **1.2-00-D/T/D**  
 Variant of application: **RR**  
 Fittings: **handle Baron** (F4)



**Attache 4A**

Color: **RAL 8016**  
 Sash surface: **RW**  
 Stained glass: **1.2-00-D/T/D**  
 Variant of application: **RR**  
 Fittings: **handle Baron** (F4)



**Attache 4B**

Color: **Italian walnut**  
 Sash surface: **RW**  
 Stained glass: **1.2-00-D/T/D**  
 Variant of application: **RR**  
 Fittings: **handle Baron** (F4)



**Attache 5**

Color: **Golden oak**  
 Sash surface: **RW**  
 Stained glass: **3.2-215-D/T/D**  
 Variant of application: **RR**  
 Fittings: **handle Lord** (F3)



**Attache 10**

Color: **Walnut**  
 Sash surface: **RW**  
 Stained glass: **3.2-244-T/D/T**  
 Variant of application: **RR**  
 Fittings: **pull handle P45**  
**handle Lord / plate** (F9)



**Attache 11**  
 Color: Mahogany  
 Sash surface: RW  
 Stained glass: 3.2-233-T/D/T  
 Variant of application: RR  
 Fittings: handle Baron (F9)



**Attache 13**  
 Color: Golden oak  
 Sash surface: RW  
 Stained glass: 3.2-215-T/D/T  
 Variant of application: RR  
 Fittings: handle Baron (F4)



**Attache 16**  
 Color: Golden oak  
 Sash surface: RW  
 Stained glass: 3.2-215-T/D/T  
 Variant of application: RR  
 Fittings: handle Baron (F4)



**Attache 17**  
 Color: RAL 7016  
 Sash surface: RW  
 Stained glass: 3.2-205-T/D/T  
 Variant of application: RR  
 Fittings: handle Baron / rosettes (F9)

Dedicated stained glass



3.2-203-T/D/T



3.2-202-T/D/T



3.2-234-T/D/T



3.1-201-T/D/T



2.1-235-T/D/T



7.1-228-T/D/T

Dedicated stained glass



3.1-206-T/D/T



7.1-207-T/D/T



3.1-208-T/D/T



5.1-209-T/D/T



3.2-215-T/D/T



3.2-205-T/D/T

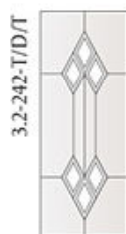

3.2-242-T/D/T



3.1-232-T/D/T



3.1-243-T/D/T



3.1-211-T/D/T

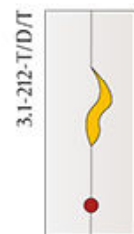

3.1-212-T/D/T

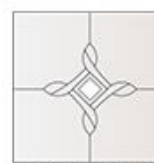

3.2-233-T/D/T

Presented in the catalog images show only a small part of our offer. In each model of composite doors, you can choose any color, equipment and stained glass designs, which the full range can be found on [www.vikking.eu](http://www.vikking.eu)



**Model: CONSUL 3**

Color: **Dark oak**  
 Sash surface: **RW**  
 Door handling: **Left to outside**  
 Door frame: **meranti**

**- optional**

Lock: **3-point strip lock** lockable by handle  
 Hinges: **adjustable 3D** in color of fittings  
 Stained glass: **3.2-242-T/D/T**  
 Variant of application: **RR**  
 Fittings: **handle Baron** (color: F4)



**Consul 2**

Color: **Dark oak**  
 Sash surface: **RW**  
 Stained glass: **3.2-229-T/D/T**  
 Variant of application: **RR**  
 Fittings: **handle Baron** (F4)



**Consul 4**

Color: **RAL 9016**  
 Sash surface: **RW**  
 Stained glass: **3.2-220-T/D/T**  
 Variant of application: **RR**  
 Fittings: **handle Lord** (white)



**Consul 5**

Color: **RAL 7040**  
 Sash surface: **RW**  
 Stained glass: **3.2-219-T/D/T**  
 Variant of application: **RR**  
 Fittings: **handle Baron** (F9)



**Consul 6**

Color: **RAL 9016**  
 Sash surface: **RW**  
 Stained glass: **3.2-219-T/D/T**  
 Variant of application: **RR**  
 Fittings: **handle Baron** (white)



**Consul 7**

Color: **Walnut**  
 Sash surface: **RW**  
 Stained glass: **3.2-236-T/D/T**  
 Variant of application: **RR**  
 Fittings: **handle Baron / rosettes** (F4)



**Consul 9**

Color: **Italian walnut**  
 Sash surface: **RW**  
 Stained glass: **3.2-238-T/D/T**  
 Variant of application: **RR**  
 Fittings: **handle Lord** (F4)





**Eminence N1**  
 Color: RAL 7013  
 Sash surface: RW  
 Fittings: handle Baron (F9)

Model: **EMINENCE N1**  
 Color: RAL 5011  
 Sash surface: RW  
 Door handling: Left to outside  
 Lock: 3-point strip lock lockable by handle  
 Hinges: adjustable 3D in color of fittings  
 Fittings: handle Baron (color: F9)



**NOTE!** Doors from the Consul collection in all models of the indicated above area have a horizontal wood graining.

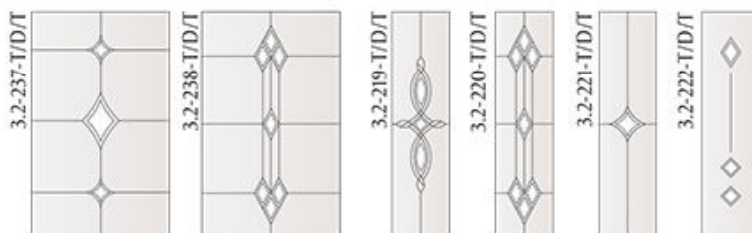

3.2-216-T/D/T



3.2-229-T/D/T



3.2-218-T/D/T



3.2-221-T/D/T



2.1-223-T/L/T

Presented in the catalog images show only a small part of our offer. In each model of composite doors, you can choose any color, equipment and stained glass designs, which the full range can be found on [www.vikking.eu](http://www.vikking.eu)



**Ambassador 1**  
Color: Italian walnut  
Sash surface: RW  
Fittings: handle Lord (F3)

Model: **AMBASSADOR 2**  
Color: Walnut  
Sash surface: RW  
Door handle: Left to outside  
Lock: 3-point strip lock lockable by handle  
Hinges: adjustable 3D in color of fittings  
Stained glass: 3.2-234-T/D/T  
Variant of application: RR  
Fittings: handle Lord (color: F4)

**Note!** The shape of presented creases is available only in PREMIUM line.

**Note!** The shape of presented creases is available only in ARCTIC line.



**Ambassador 1A\***  
Color: Swamp oak  
Sash surface: RW  
Fittings: handle Baron (F4)



**Ambassador 2A\***  
Color: Swamp oak  
Sash surface: RW  
Stained glass: 3.2-202-T/D/T  
Variant of application: RR  
Fittings: handle Baron / rosettes (F4)

**Dedicated stained glass**





Model: **PRESIDENT 2**  
 Color: **Golden oak**  
 Sash surface: **RW**  
 Door handling: **Right to outside**  
 Lock: **3-point strip lock lockable by handle**  
 Hinges: **adjustable 3D in color of fittings**  
 Stained glass: **3.1-239-F/D/F**  
 Variant of application: **RR**  
 Fittings: **handle Lord (color: F4)**



Dedicated stained glass

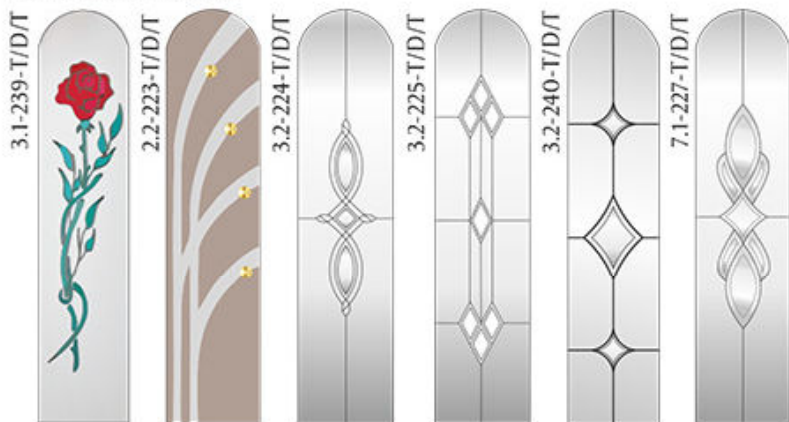

**President 1\***  
 Color: **Dark oak**  
 Sash surface: **RW**  
 Fittings: **handle Lord (F3)**



**President 2\***  
 Color: **Swamp oak**  
 Sash surface: **RW**  
 Stained glass: **3.2-224-F/D/F**  
 Variant of application: **RR**  
 Fittings: **handle Lord (F9)**

\*In ARCTIC Plus line: model is available on a separate request



*Open up to new possibilities*

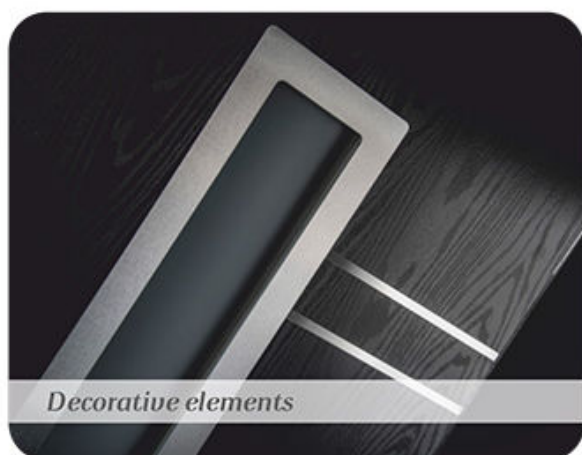
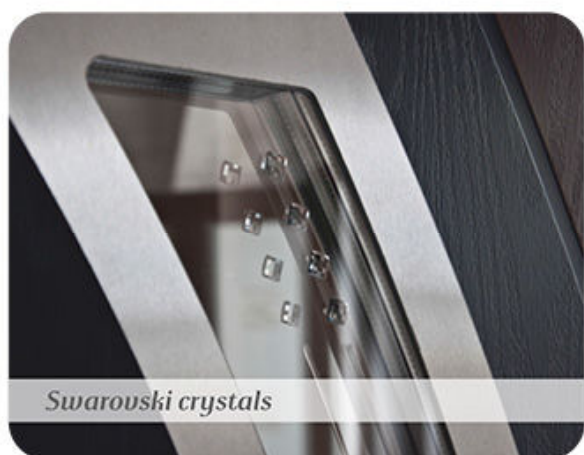
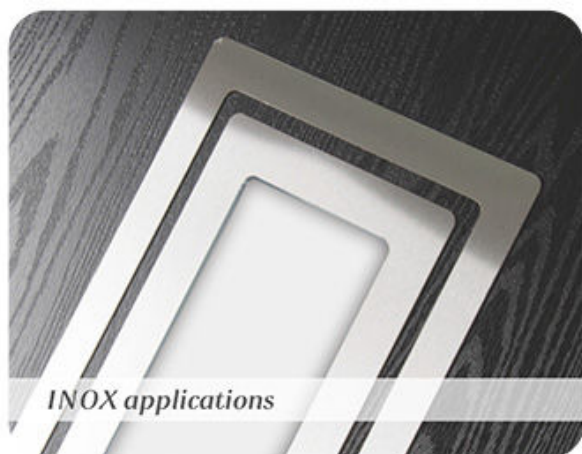
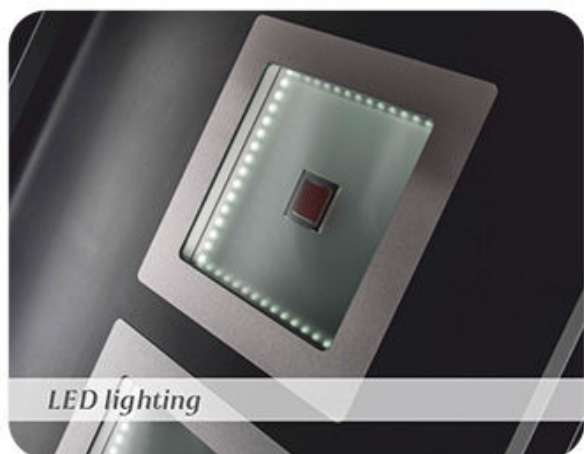



## DIPLOMAT 4U

Sidelights - variant II

Color: RAL 7021

Left opening to outside

Fingerprint Reader

- optional

3-point strip lock lockable automatically

Stained glass: 3.1-128-D/T/D

Variant of application: RN

Pull handle P45 L = 1600 mm



## DIPLOMAT 4T

Sidelights - variant II

Color: RAL 7021

Right opening to outside

3-point strip lock lockable by cylinder

Stained glass: an individual project

- optional

Variant of application: RN

Pull handle P45 L = 800 mm

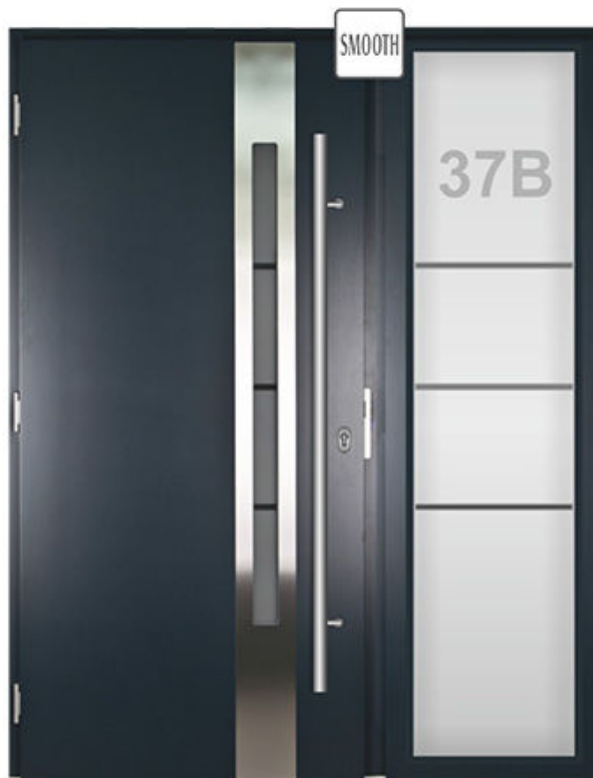

## DIPLOMAT 4M

Sidelight - variant I

Color: RAL 7016

Left opening to outside

Mechanical locking plate

- optional

3-point strip lock lockable by cylinder

Stained glass: 3.1-127-D/T/D

Variant of application: RN - asymmetric position

- optional

Pull handle P45 L = 1600 mm

**Permanently and aesthetically mark  
the number of your home**

(send request:  
wyceny@vikking.eu)

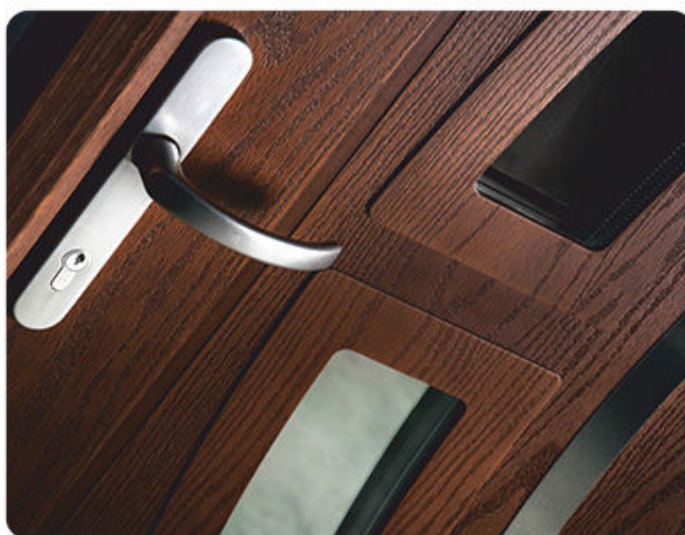

### DIPLMAT 20 - projekt niestandardowy

Sidelight - uariant Ia - battens 3 pcs.

- optional

Color: Italian walnut

Left opening to outside

3-point strip lock lockable by handle

Stained glass: 14-00-T/F/R

Variant of application: KZ+RN+F

- optional

Handle Lord (color: F9)

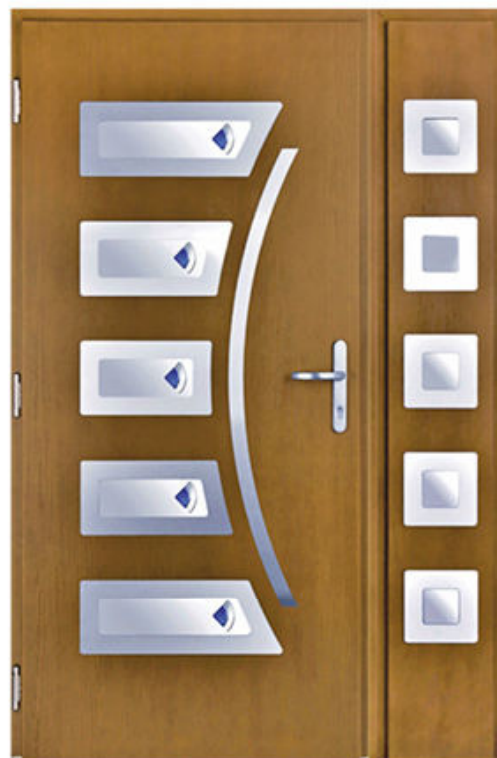

### DIPLMAT 4M

Sidelight - variant II

Color: RAL 8007

Left opening to outside

Bluetooth

- optional

3-point strip lock lockable automatically

Stained glass: 3.1-128-D/T/D

Variant of application: RZ

Pull handle P45 L = 1600 mm

### DIPLMAT 26

Sidelight - variant I - filling: composite panel with glazings -

optional

Color: Winchester

Left opening to outside

3-point strip lock lockable by handle

Stained glass: individual project

Variant of application: RN

Handle Lord (color F9)



## DIPLOMAT 6C / 4i

Double door

- optional

Color: RAL 7016/7040

Left opening to outside

3-point strip lock lockable by handle

Stained glass: 3.2-46-T/F/R

Variant of application: RN

Handle Baron (color: F9)



## DIPLOMAT 6A

Sidelights - variant II

Color: RAL 9016

Right opening to outside

3-point strip lock lockable by handle

Stained glass: 1.2-00-D/T/D

Variant of application: RN

Handle Lord (color F9)



## DIPLOMAT 68

Sidelight - variant I

Color: RAL 7040/9007

Left opening to outside

Fingerprint Reader

- optional

3-point strip lock lockable automatically

Stained glass: 3.2-53-T/F/R

Variant of application: RZ

Pull handle Q45 L = 1200 mm





**DIPLOMAT 58**

Sidelights - variant II  
 Color: RAL 7016  
 Right opening to outside  
 3-point strip lock lockable by handle  
 Stained glass: 3.1-126-T/D/T  
 Variant of application: RN  
 Handle Lord (color F9)



**DIPLOMAT 22**

Sidelight - variant I  
 Color: RAL 7016  
 Right opening to outside  
 3-point strip lock lockable by cylinder  
 Stained glass: 1.2-00-D/T/D  
 Variant of application: RN  
 Pull handle P45B



**DIPLOMAT 44**

Sidelight - variant I  
 Color: RAL 9016  
 Right opening to outside  
 3-point strip lock lockable by cylinder  
 Stained glass: 2.2-95-T/D/T  
 Variant of application: RN  
 Pull handle P45 L = 1600 mm



## DIPLOMAT 62

Color: Dark oak / Walnut

- optional

Left opening to outside

3-point strip lock lockable by handle

Stained glass: 2.2-43-T/D/T

Variant of application: RN - INOX finish frame painted in color F4

- optiona

Handle Lord (color F4)

PL



## DIPLOMAT - an individual project

Color: Walnut

Left opening to outside

3-point strip lock lockable by handle

Variant of application: RN - INOX

- optional

Handle Lord (color F9)



## PRESIDENT 2

Sidelights - variant Va

Color: Golden oak

Left opening to outside

3-point strip lock lockable by handle

Stained glass: an individual project - optional

Variant of application: RR

Handle Lord (color F4)



**CONSUL 3**

Top light - variant III  
 Color: Dark oak  
 Left opening to inside  
 3-point strip lock  
 lockable by handle  
 Stained glass: 3.2-229-T/D/T  
 and 3.2-242-T/D/T  
 Variant of application: RR  
 Handle Lord (color F4)



**AMBASSADOR 2A**

Sidelights - individual project  
 - optional  
 Color: Swamp oak  
 Left opening to outside  
 4-point strip lock lockable by cylinder  
 - optional  
 Stained glass: 3.2-202-T/D/T  
 Variant of application: RR  
 Handle Baron / rosettes (color F4)



**PRESIDENT 2**

Top light - variant III  
 Color: Golden oak  
 Right opening to outside  
 3-point strip lock  
 lockable by handle  
 Stained glass: 7.1-227-T/D/T  
 Variant of application: RR  
 Handle Lord (color F4)



**PRESIDENT 1**

Sidelights - variant II  
 Color: Italian walnut  
 Right opening to outside  
 3-point strip lock  
 lockable by handle  
 Stained glass: 1.2-00-D/T/D  
 Handle Lord (color F4)



**AMBASSADOR 2**

Sidelights - variant II - filling: composite panel with glazings  
 - optional  
 Color: RAL 9016  
 Right opening to outside  
 4-point strip lock lockable by cylinder  
 - optional  
 Stained glass: 7.1-228-T/D/T  
 and 3.2-219-T/D/T  
 Variant of application: RR  
 Handle Lord / rosettes (color F4)



## OPTIMAL line ★★

Composite doors of OPTIMAL line have an excellent quality products with well-balanced design and high performance. Their additional advantage is the long-term durability combined with a minimum of maintenance. The optimal offer for those, who is looking for excellent quality doors at affordable prices.

Protection factor against heat loss -  $U_p$  from 0,85 W/m<sup>2</sup>K

### Purpose of door:

- ✓ Entrance external doors dedicated to housing, opening to the outside or inside
- ✓ Entrance internal doors.

### Standard equipment:

- ✓ composite sash 45 mm in the rebate version of wood-like surface Real Wood structure
- ✓ PVC door frame 70 mm made of six-chamber profile class A of wood-like surface Real Wood structure,
- ✓ door set finally painted with the highest quality lacquers in the full range of RAL colors optional: in one of the wood decors - see price list,
- ✓ low aluminium threshold with thermal barrier, optional: with the system of insulating profiles - see price list,
- ✓ three 3D adjustable hinges with increased resistance to burglary,
- ✓ three-point anti-theft strip lock, lockable by handle, optional: anti-theft blockade system - see price list,
- ✓ 3 locking plates made of stainless steel,
- ✓ double sealing system around the edges
- ✓ in versions with glazing: triple glazed units decorated with use of resin technology.

**Optional:** custom projects - see price list.

**Dedicated fittings:** see price list.

**Note!** Doors of OPTIMAL line are resistant to moisture, but they still should be protected by use of roofing, that provides full protection against sunlight, which may, in extreme circumstances result in short-term deformation of the sash.



## INTERIOR line ★

Composite entrance doors of INTERIOR line have a timeless solutions that combines durability, safety and aesthetics of the non-rebated sashes.

Protection factor against heat loss -  $U_p$  from 1,0 W/m<sup>2</sup>K

### Purpose of door:

- ✓ Entrance internal doors,
- ✓ Entrance external doors opening to the outside or inside,
- ✓ technical doors and indoor doors - composite sashes have above-average resistance to heavy utilization and vandalism, while maintaining excellent protection against cold, noise and burglary,
- ✓ perfect especially for facilities with high usage and requirements of above-average moisture resistance.

### Standard equipment:

- ✓ composite sash 45 mm in the non-rebated version of wood-like surface Real Wood structure,
- ✓ PVC door frame 70 mm made of five-chamber profile of wood-like surface Real Wood structure,
- ✓ door set finally painted with the highest quality lacquers in the full range of RAL colors optional: in one of the wood decors - see price list,
- ✓ low aluminium threshold with thermal barrier,
- ✓ three 3D adjustable hinges,
- ✓ mortise lock 72mm x 45mm, optional: additional upper lock or three-point anti-theft strip lock lockable by handle, see price list,
- ✓ adjustable locking plates,
- ✓ triple sealing system of door frame and double sealing of threshold,
- ✓ in versions with glazing: triple glazed units decorated with use of resin technology.

**Optional:** custom projects - see price list.

**Dedicated fittings:** see price list.

**Note!** Doors of INTERIOR line are resistant to moisture, but they still should be protected by use of roofing, that provides full protection against sunlight, which may, in extreme circumstances result in short-term deformation of the sash.





SMOOTH



SMOOTH

**Diplomat S**  
Color: RAL 7047  
Sash surface: SMOOTH  
Fittings: handle Lord (F9)

**Model: DIPLOMAT OK**

Color: RAL 7021

Sash surface: SMOOTH

- optional

Door handling: Left to outside

Lock: 3-point strip lock lockable by handle

Hinges: adjustable 3D in color of fittings

Variant of application: F

Fittings: handle Lord (color: F9)



**Diplomat 9**  
Color: RAL 7038  
Sash surface: RW  
Variant of application: F  
Fittings: pull handle P45  
handle Lord / rosette (F9)



**Diplomat 0B**  
Color: RAL 7035  
Sash surface: RW  
Variant of application: F  
Fittings: handle Prince (F9)



**Diplomat 0E**  
Color: RAL 7023  
Sash surface: RW  
Variant of application: F  
Fittings: handle Prince (F9)



**Diplomat 0F**  
Color: RAL 7003  
Sash surface: RW  
Variant of application: F  
Fittings: pull handle P45  
handle Lord/rosette (F9)



**Diplomat 0H**  
Color: RAL 8001  
Sash surface: RW  
Variant of application: F  
Fittings: handle Prince (F9)

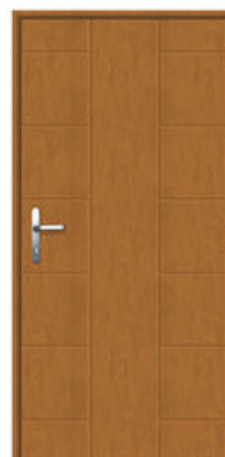

**Diplomat 0i**  
Color: RAL 8001  
Sash surface: RW  
Variant of application: F  
Fittings: handle Prince (F9)



**Diplomat 0J**  
Color: RAL 7021  
Sash surface: RW  
Variant of application: F  
Fittings: handle Prince (F9)



**Diplomat 0L**  
Color: RAL 5014  
Sash surface: RW  
Variant of application: F  
Fittings: handle Prince (F9)



**Diplomat 0M**  
Color: RAL 7039  
Sash surface: RW  
Variant of application: F  
Fittings: handle Prince (F9)



**Diplomat 0N**  
Color: Winchester  
- optional  
Sash surface: RW  
Variant of application: F  
Fittings: handle Prince (F9)



**Diplomat 0P**  
Color: RAL 7046  
Sash surface: RW  
Variant of application: F  
Fittings: handle Prince (F9)



**Diplomat 21**  
Color: RAL 9016  
Sash surface: RW  
Stained glass: 1.2-00-D/F/D  
Variant of application: RN+LC  
(LC - optional)  
Fittings: pull handle P45B  
handle Lord / rosette (F9)



Model: **DIPLOMAT 2A**  
Color: Italian walnut  
- optional  
Sash surface: RW  
Door handling: Right to inside  
Lock: 3-point strip lock lockable by handle  
Hinges: adjustable 3D in colour of fittings  
Stained glass: 1.2-00-D/F/D  
Variant of application: RN  
Fittings: handle Lord (color: F9)

#### Dedicated stained glass



Presented in the catalog images show only a small part of our offer.

In each model of composite doors, you can choose any color, equipment and stained glass designs, which the full range can be found on [www.viiking.eu](http://www.viiking.eu)

Presented door models in the optimal group are available as standard in  OPTIMAL and  INTERIOR lines



**Model: DIPLOMAT 4D**

Color: **Mahogany - optional**  
 Sash surface: RW  
 Door handling: **Left to outside**  
 Lock: **3-point strip lock** lockable by handle  
 Hinges: **adjustable 3D** in color of fittings  
 Stained glass: **3.1-411-F/D/F**  
 Variant of application: RN  
 Fittings: **handle Baron** (color: F9)



**Diplomat 40**

Color: **RAL 5022**  
 Sash surface: RW  
 Stained glass: **1.2-00-D/F/D**  
 Variant of application: RN  
 Fittings: **handle Prince** (F9)



**Diplomat 4A**

Color: **Golden oak - optional**  
 Sash surface: RW  
 Stained glass: **3.1-411-F/D/F**  
 Variant of application: RN  
 Fittings: **handle Lord** (F4)



**Diplomat 4B**

Color: **RAL 7000**  
 Sash surface: RW  
 Stained glass: **1.2-00-D/F/D**  
 Variant of application: RN  
 Fittings: **handle Prince**



**Diplomat 85**

Color: **RAL 6015**  
 Sash surface: RW  
 Stained glass: **3.1-422-F/D/F**  
 Variant of application: RN  
 Fittings: **handle Prince** (F9)

**Dedicated stained glass**



3.1-411-F/D/F

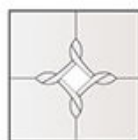

3.1-410-F/D/F



3.1-409-F/D/F



3.1-422-F/D/F





Model: **DIPLOMAT 41**  
 Color: **RAL 7016**  
 Sash surface: **RW**  
 Door handling: **Left to outside**  
 Lock: **single point mortise lock**  
 Hinges: **adjustable 3D in color of fittings**  
 Stained glass: **1.2-00-D/F/D**  
 Variant of application: **RN**  
 Fittings: **handle Specjal (Color: brass-patina)**



**Diplomat 44**  
 Color: **Golden oak**  
 - optional  
 Sash surface: **RW**  
 Stained glass: **1.2-00-D/F/D**  
 Variant of application: **RN**  
 Fittings: **handle Lord (F4)**

#### Dedicated stained glass



3.1-415-F/D/F

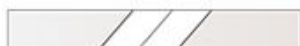

3.1-416-F/D/F



**Diplomat 50**  
 Color: **RAL 9004**  
 Sash surface: **RW**  
 Stained glass: **3.1-415-D/F/D**  
 Variant of application: **RN**  
 Fittings: **handle Prince (F9)**



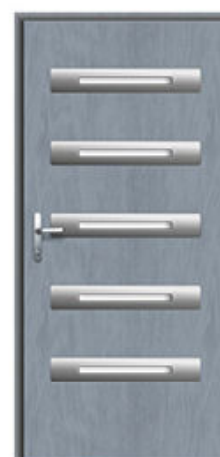

**Diplomat 51**  
 Color: **RAL 7000**  
 Sash surface: **RW**  
 Stained glass: **3.1-415-F/D/F**  
 Variant of application: **RN**  
 Fittings: **klamka Prince (F9)**



**Diplomat 5A**  
 Color: **RAL 7040**  
 Sash surface: **RW**  
 Stained glass: **1.2-00-D/F/D**  
 Variant of application: **RN**  
 Fittings: **handle Prince (F9)**

Presented in the catalog images show only a small part of our offer.

In each model of composite doors, you can choose any color, equipment and stained glass designs, which the full range can be found on [www.vikking.eu](http://www.vikking.eu)

Presented door models in the optimal group are available as standard in  OPTIMAL and  INTERIOR lines



**Diplomat 43**  
 Color: RAL 7016  
 Sash surface: RW  
 Stained glass: 3.1-406-D/F/D  
 Variant of application: RN  
 Fittings: handle Prince (F9)

Model: **DIPLOMAT 42**  
 Color: RAL 9016  
 Sash surface: RW  
 Door handling: Left to outside  
 Lock: 3-point strip lock lockable by handle  
 Hinges: adjustable 3D in color of fittings  
 Stained glass: 1.2-00-D/F/D  
 Variant of application: RN  
 Fittings: handle Lord (color: white)



**Diplomat 45**  
 Color: RAL 8017  
 Sash surface: RW  
 Stained glass: 3.1-407-F/D/F  
 Variant of application: RN  
 Fittings: handle Prince (F9)



**Diplomat 46**  
 Color: Walnut  
 - optional  
 Sash surface: RW  
 Stained glass: 1.2-00-D/F/D  
 Variant of application: RN  
 Fittings: handle Prince (F9)



**Diplomat 48**  
 Color: RAL 7035  
 Sash surface: SMOOTH  
 - optional  
 Stained glass: 1.2-00-D/F/D  
 Variant of application: RN  
 Fittings: handle Prince (F9)



**Diplomat 4H**  
 Color: Italian walnut  
 - optional  
 Sash surface: RW  
 Stained glass: 1.2-00-D/F/D  
 Variant of application: RN  
 Fittings: handle Prince (F9)

### Dedicated stained glass

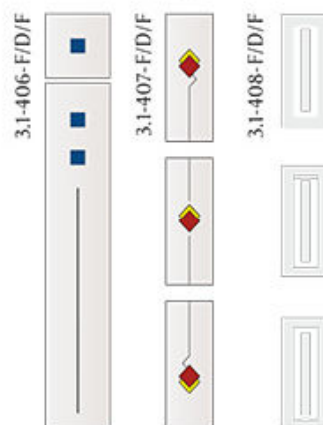



**Diplomat 4i**  
Color: RAL 7021  
Sash surface: RW  
Stained glass: 3.1-401-F/D/F  
Variant of application: RN  
Fittings: handle Prince (F9)



**Diplomat 4j**  
Color: RAL 7021  
Sash surface: RW  
Stained glass: 1.2-00-D/F/D  
Variant of application: RN  
Fittings: handle Prince (F9)



**Diplomat 4K**  
Color: RAL 5004  
Sash surface: RW  
Stained glass: 1.2-00-D/F/D  
Variant of application: RN  
Fittings: handle Prince (F9)



**Diplomat 4Z**  
**model available only in INTERIOR line**  
Color: RAL 7040  
Sash surface: RW  
Stained glass: 1.2-00-D/F/D  
Variant of application: KW  
Fittings: pull handle P45 handle Lord/rosette (F9)



#### DIPLOMAT 4P

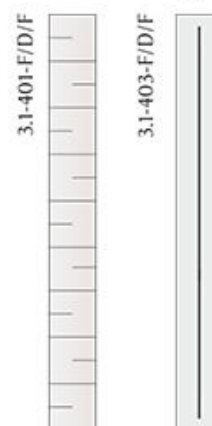

Color: RAL 7016  
Sash surface: RW  
Door handling: **Right to outside**  
Lock: **3-point strip lock** lockable by handle  
Hinges: **adjustable 3D** in color of fittings  
Stained glass: 1.2-00-D/F/D  
Variant of application: RN  
Fittings: handle Lord (color: F9)

#### Dedicated stained glass



Presented in the catalog images show only a small part of our offer.

In each model of composite doors, you can choose any color, equipment and stained glass designs, which the full range can be found on [www.viksking.eu](http://www.viksking.eu)

Presented door models in the optimal group are available as standard in  OPTIMAL and  INTERIOR lines



Model: **DIPLOMAT 7E**

Color: **Italian walnut**

- optional

Sash surface: **RW**

Door handling: **Left to outside**

Lock: **3-point strip lock** lockable by handle

Hinges: **adjustable 3D** in color of fittings

Stained glass: **1.2-00-D/F/D**

Variant of application: **RN**

Fittings: **handle Prince** (color: F9)



**Diplomat 6I**

Color: **RAL 7026**

Sash surface: **RW**

Stained glass: **1.2-00-D/F/D**

Variant of application: **RN**

Fittings: **handle Baron** (F9)



**Diplomat 6C**

Color: **RAL 7021**

Sash surface: **RW**

Stained glass: **1.2-00-D/F/D**

Variant of application: **RN**

Fittings: **handle Prince** (F9)

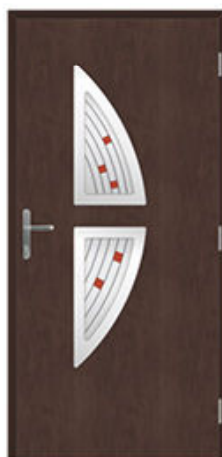

**Diplomat 6F**

Color: **RAL 8017**

Sash surface: **RW**

Stained glass: **3.1-428-F/D/F**

Variant of application: **RN**

Fittings: **handle Prince** (F9)



**Diplomat 7A**

Color: **RAL 7026**

Sash surface: **RW**

Stained glass: **3.1-430-F/D/F**

Variant of application: **RN**

Fittings: **handle Prince** (F9)

## Dedykowane witraże

3.1-430-F/D/F



3.1-426-F/D/F



2.1-429-F/D/F



3.1-428-F/D/F



**Diplomat 84**

Color: **Golden oak**

- optional

Sash surface: **RW**

Stained glass: **1.2-00-D/F/D**

Variant of application: **RN**

Fittings: **handle Lord** (F9)

**FABULOUS INSPIRATIONS**

Presented above decorated stained-glass units are made in our atelier for individual orders.  
If you are looking for original solutions in the field of stained glass - please contact us: [wyceny@vikking.eu](mailto:wyceny@vikking.eu).  
We invite you to visit: [witraze.vikking.eu](http://witraze.vikking.eu)



**Attache 1**  
 Color: **Golden oak**  
 - optional  
 Sash surface: **RW**  
 Fittings: **handle Prince (F9)**

Model: **ATTACHE 10**  
 Color: **Walnut - optional**  
 Sash surface: **RW**  
 Door handling: **Left to inside**  
 Lock: **3-point strip lock** lockable by handle  
 Hinges: **adjustable 3D** in color of fittings  
 Stained glass: **1.2-00-D/F/D**  
 Variant of application: **RR**  
 Fittings: **handle Baron (color: F4)**  
 Drip cap color **F9 - optional**



**Attache 2**  
 Color: **RAL 8017**  
 Sash surface: **RW**  
 Stained glass: **3.1-503-F/D/F**  
 Variant of application: **RR**  
 Fittings: **handle Prince (F9)**



**Attache 4**  
 Color: **RAL 5009**  
 Sash surface: **RW**  
 Stained glass: **1.2-00-D/F/D**  
 Variant of application: **RR**  
 Fittings: **handle Prince (F9)**

**Attache 4A**  
 Color: **RAL 5014**  
 Sash surface: **RW**  
 Stained glass: **1.2-00-D/F/D**  
 Variant of application: **RR**  
 Fittings: **handle Prince (F9)**



**Attache 4B**  
 Color: **Walnut**  
 - optional  
 Sash surface: **RW**  
 Stained glass: **1.2-00-D/F/D**  
 Variant of application: **RR**  
 Fittings: **handle Baron (F4)**



**Attache 5**  
 Color: **Golden oak**  
 - optional  
 Sash surface: **RW**  
 Stained glass: **3.1-509-F/D/F**  
 Variant of application: **RR**  
 Fittings: **handle Lord (F3)**



**Attache 11**  
 Color: **Mahogany**  
 - optional  
 Sash surface: **RW**  
 Stained glass: **3.1-510-F/D/F**  
 Variant of application: **RR**  
 Fittings: **handle Prince (F9)**



Model: **ATTACHE 14**

Color: **Mahogany**

- optional

Sash surface: **RW**

Door handling: **Right to outside**

Lock: **3-point lockable with handle**

Hinges: **adjustable 3D in color of fittings**

Stained glass: **1.2-00-D/F/D**

Variant of application: **RR**

Fittings: **handle Lord (kolor: F9)**



Attache 13

Color: **Golden oak**

- optional

Sash surface: **RW**

Stained glass: **3.1-511-F/D/F**

Variant of application: **RR**

Fittings: **handle Baron (F4)**



Attache 16

Color: **Walnut**

- optional

Sash surface: **RW**

Stained glass: **3.1-511-F/D/F**

Variant of application: **RR**

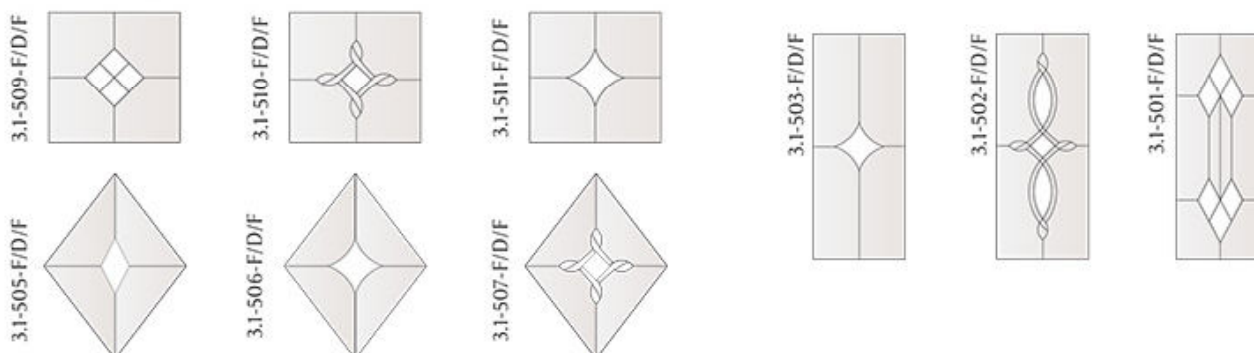

Fittings: **handle Baron (F4)**

Dedicated stained glass



Presented in the catalog images show only a small part of our offer.

In each model of composite doors, you can choose any color, equipment and stained glass designs, which the full range can be found on [www.viksking.eu](http://www.viksking.eu)

Presented door models in the optimal group are available as standard in  OPTIMAL and  INTERIOR lines



Model: **CONSUL 2**  
 Color: **Walnut**  
 - optional  
 Sash surface: **RW**  
 Door handling: **Right to outside**  
 Lock: **3-point strip lock** lockable by handle  
 Hinges: **adjustable 3D** in color of fittings  
 Stained glass: **3.1-517-F/D/F**  
 Variant of application: **RR**  
 Fittings: **handle Lord** (color: F4)



Model: **Consul 3**  
 Color: **Walnut**  
 - optional  
 Sash surface: **RW**  
 Stained glass: **3.1-501-F/D/F**  
 Variant of application: **RR**  
 Fittings: **handle Lord** (F4)



Model: **Consul 4**  
 Color: **Walnut**  
 - optional  
 Sash surface: **RW**  
 Stained glass: **3.1-514-F/D/F**  
 Variant of application: **RR**  
 Fittings: **handle Lord** (F4)

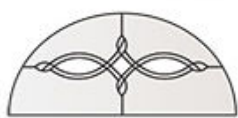

3.1-518-F/D/F



3.1-517-F/D/F

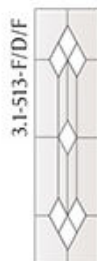

3.1-513-F/D/F

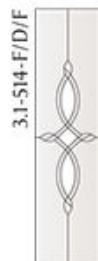

3.1-514-F/D/F



3.1-515-F/D/F



Model: **Consul 5**  
 Color: **Golden oak**  
 - optional  
 Sash surface: **RW**  
 Stained glass: **3.1-514-F/D/F**  
 Variant of application: **RR**  
 Fittings: **handle Lord** (F4)



Model: **Consul 6**  
 Color: **RAL 9016**  
 Sash surface: **RW**  
 Stained glass: **3.1-514-F/D/F**  
 Variant of application: **RR**  
 Fittings: **handle Lord** (white)



Model: **Consul 7**  
 Color: **Walnut**  
 - optional  
 Sash surface: **RW**  
 Stained glass: **3.1-528-F/D/F**  
 Variant of application: **RR**  
 Fittings: **handle Lord** (F4)



Model: **Consul 9**  
 Color: **Mahogany**  
 - optional  
 Sash surface: **RW**  
 Stained glass: **3.1-529-F/D/F**  
 Variant of application: **RR**  
 Fittings: **handle Lord** (F4)



3.1-529-F/D/F



3.1-528-F/D/F





Model: **PRESIDENT 2**  
 Color: **RAL 9016**  
 Sash surface: **RW**  
 Door handling: **Left to outside**  
 Lock: **3-point strip lock** lockable by handle  
 Hinges: **adjustable 3D** in color of fittings  
 Stained glass: **1.2-00-D/F/D**  
 Variant of application: **RR**  
 Fittings: **handle Prince** (color: F9)



President 1  
 Color: **Orzech**  
 - optional  
 Sash surface: **RW**  
 Fittings: **handle Lord** (F3)

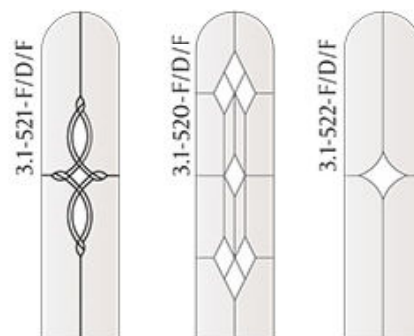

Model: **AMBASSADOR 2**  
 Color: **RAL 7043**  
 Sash surface: **RW**  
 Door handling: **Right to outside**  
 Lock: **1-point mortise lock**  
 Hinges: **adjustable 3D** in color of fittings  
 Stained glass: **3.1-524-F/D/F**  
 Variant of application: **RR**  
 Fittings: **handle Special** (color: brass-patina)



3.1-524-F/D/F



3.1-525-F/D/F



3.1-526-F/D/F



Attache 17  
 Color: **RAL 7016**  
 Sash surface: **RW**  
 Stained glass: **1.2-00-D/F/D**  
 Variant of application: **RR**  
 Fittings: **handle Prince** (F9)



Ambassador 1  
 Color: **Orzech**  
 - optional  
 Sash surface: **RW**  
 Fittings: **Kora** (nickel-chrome)

## The most popular colors of composite doors

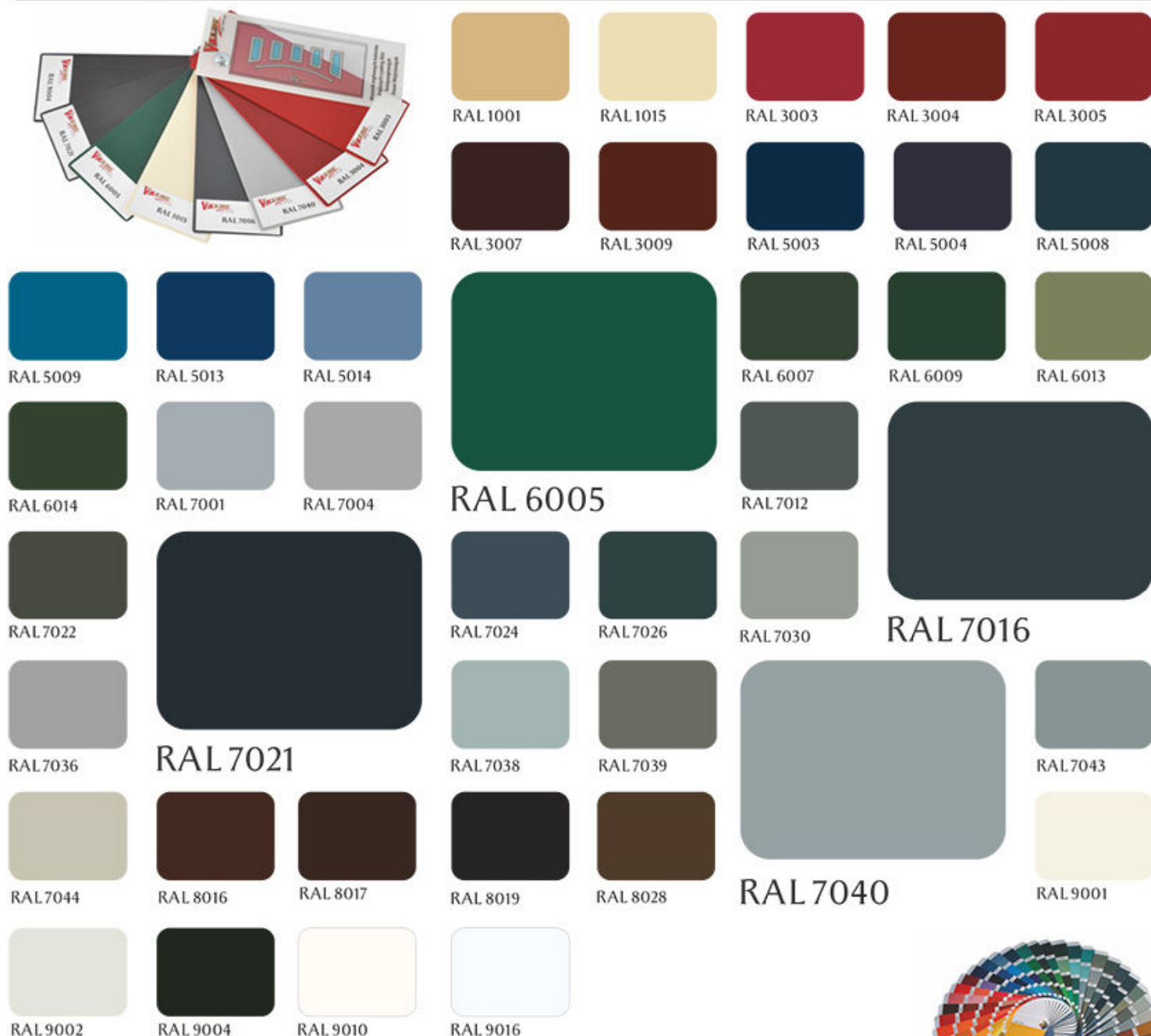
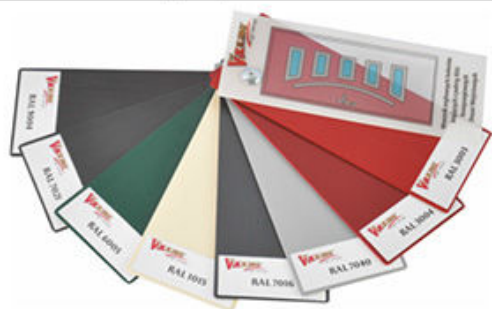

Above we present the RAL colors, in which the most common are painted composite doors. Our customers have access to a full range of RAL and they decide about the color of their doors of dream.

For lovers of precious wood colors, we offer to choose from one of the many decors created by hand by craftsmen with the highest qualifications.



Composite doors VIKKING can be painted in two colors (divided into the outer side and an inner side), as well as several colors on each side.



# Style, design, color - especially for you

**Bevels - the beauty of grinded glass**

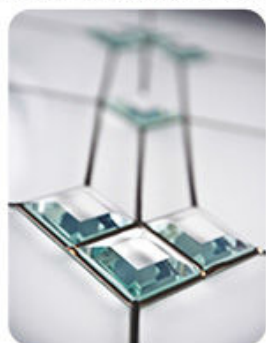

**Swarovski - the jewellery of your door**

**Fusing - the colors fired in the glass**

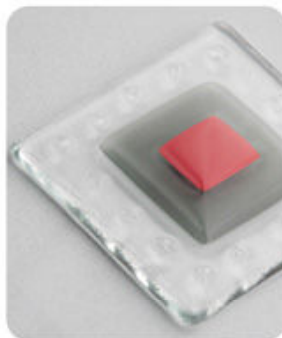

**Inox - charm of stainless steel**



**Laser decorations - style and precision**



**Resin - festival of colors**

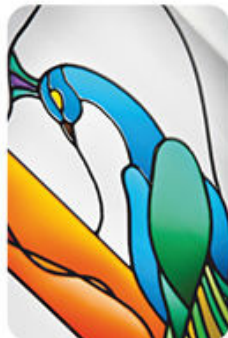
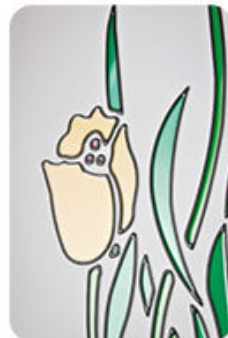

**LED lighting - bright accent of your home**



Small bubbles, lines, pollen, inclusions and surface imperfections are natural properties of stained glass decorations. They are not considered to be defects. Assessment of defects must be made at the daily diffused light, with the unaided eye from a distance of at least 1 m looking at right angles.

# Standard dimensions of doors

LINE	Collection / Model	The external dimension of the door frame		The recommended size of the wall opening		The internal dimension of the door frame		Maximum shortening / narrowing of the door	Sash size		
		PVC	Meranti	PVC	Meranti	PVC	Meranti		s	h	
		S1 x H1	S1 x H1	S2 x H2	S2 x H2	S0 x H0	S0 x H0				
ARCTIC Plus	Diplomat, Attache	1045 x 2100	1030 x 2090	1070 x 2120	1060 x 2100	885 x 2000	880 x 1995	Unbound ***	950	2040	
		1075 x 2100	1060 x 2090	1100 x 2120	1090 x 2100	915 x 2000	910 x 1995		970	2040	
		1095 x 2210	1080 x 2200	1120 x 2230	1110 x 2210	935 x 2110	930 x 2105		1000	2150	
ARCTIC	Diplomat, Attache	920 x 2065	935 x 2070	950 x 2080	960 x 2080	790 x 1975	785 x 1980	Unbound ***	838	2013	
		1000 x 2065	1010 x 2070	1030 x 2080	1040 x 2080	865 x 1975	860 x 1980		914	2013	
		1035 x 2090	1045 x 2095	1060 x 2100	1070 x 2110	900 x 2005	895 x 2005		950	2040	
		1085 x 2200	1095 x 2205	1110 x 2210	1120 x 2220	950 x 2115	945 x 2115		1000	2150	
	P*; A*; C*; E*	1000 x 2065	1010 x 2070	1030 x 2080	1040 x 2080	865 x 1975	860 x 1980	120 / 40	914	2013	
PREMIUM	Diplomat, Attache	920 x 2065	935 x 2070	950 x 2080	960 x 2080	790 x 1975	785 x 1980	Unbound ***	838	2013	
		1000 x 2065	1010 x 2070	1030 x 2080	1040 x 2080	865 x 1975	860 x 1980		914	2013	
		1035 x 2090	1045 x 2095	1060 x 2100	1070 x 2110	900 x 2005	895 x 2005		950	2040	
		1085 x 2200	1095 x 2205	1110 x 2210	1120 x 2220	950 x 2115	945 x 2115		1000	2150	
		President „80”	920 x 2065	935 x 2070	950 x 2080	960 x 2080	790 x 1975	785 x 1980	120 / 0	838	2013
		P*; A*; C*; E*	1000 x 2065	1010 x 2070	1030 x 2080	1040 x 2080	865 x 1975	860 x 1980	120 / 0	914	2013
	Ambassador „95”	1020 x 2080	1030 x 2085	1050 x 2090	1060 x 2100	885 x 1995	880 x 1995	120 / 0	935	2030	
OPTIMAL	Diplomat, Attache	920 x 2065	-	950 x 2080	-	790 x 1975	-	120 / 0	838	2013	
		1000 x 2065	-	1030 x 2080	-	865 x 1975	-	120 / 0	914	2013	
		President „80”	920 x 2065	-	950 x 2080	-	790 x 1975	-	120 / 0	838	2013
		P*; A*; C*; E*	1000 x 2065	-	1030 x 2080	-	865 x 1975	-	120 / 0	914	2013
		Ambassador „95”	1020 x 2080	-	1050 x 2090	-	885 x 1995	-	120 / 0	935	2030
INTERIOR	Diplomat, Attache	950 x 2085	-	980 x 2100	-	810 x 1990	-	Unbound ***	838	2013	
		1025 x 2085	-	1050 x 2100	-	885 x 1990	-		914	2013	
		1060 x 2115	-	1090 x 2130	-	920 x 2015	-		950	2040	
		President „80”	950 x 2085	-	980 x 2100	-	810 x 1990	-	120 / 0	838	2013
		P*; A*; C*; E*	1025 x 2085	-	1050 x 2100	-	885 x 1990	-	120 / 0	914	2013
		Ambassador „95”	1045 x 2105	-	1070 x 2120	-	905 x 2005	-	120 / 0	935	2030

Caption: P\* - President; A\* - Ambassador; C\* - Consul; E\* - Eminence.

- ✓ Dimension tolerance in accordance with PN: up to 1 m: +/- 1 mm; over 1 m +/- 2 mm.
- ✓ All door models of the ARCTIC Plus, ARCTIC, PREMIUM line in Diplomat and Attache collections, on request can be narrowed or shortened in any size - see price list.

\*\*Maximum modification parameters of door with glazings are limited by the shapes and dimensions of stained glass.

Optional: all door models may have a door frame extensions - see price list.

Double doors, sidelights, top lights and custom projects (with the exception of technical limitations) are carried out according to individual orders - please contact us: [wyceny@vikking.eu](mailto:wyceny@vikking.eu) or [bok@vikking.eu](mailto:bok@vikking.eu)

*For you we are flexible*

# Schemes of door

The scheme of door in the rebate version

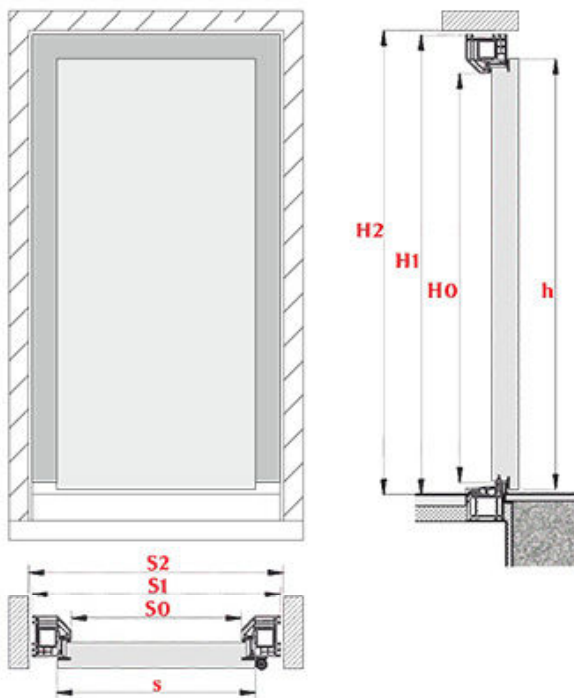

The scheme of door in non-rebated version

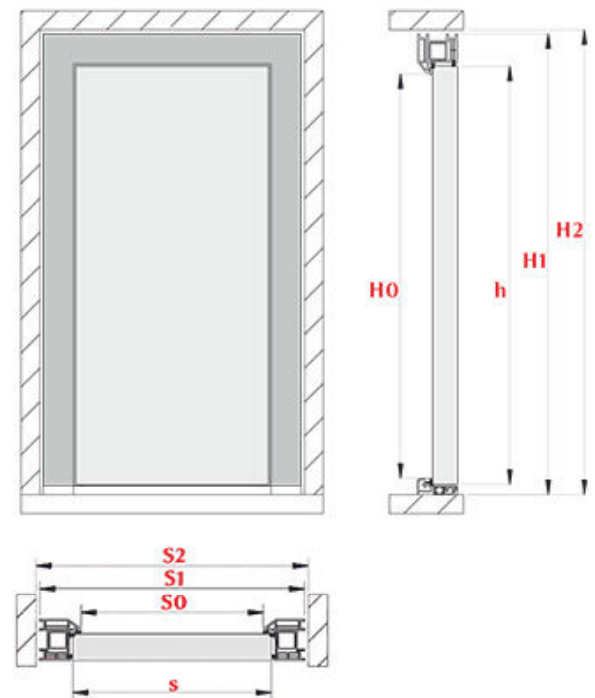

# Variants of opening the door - seen from the outside

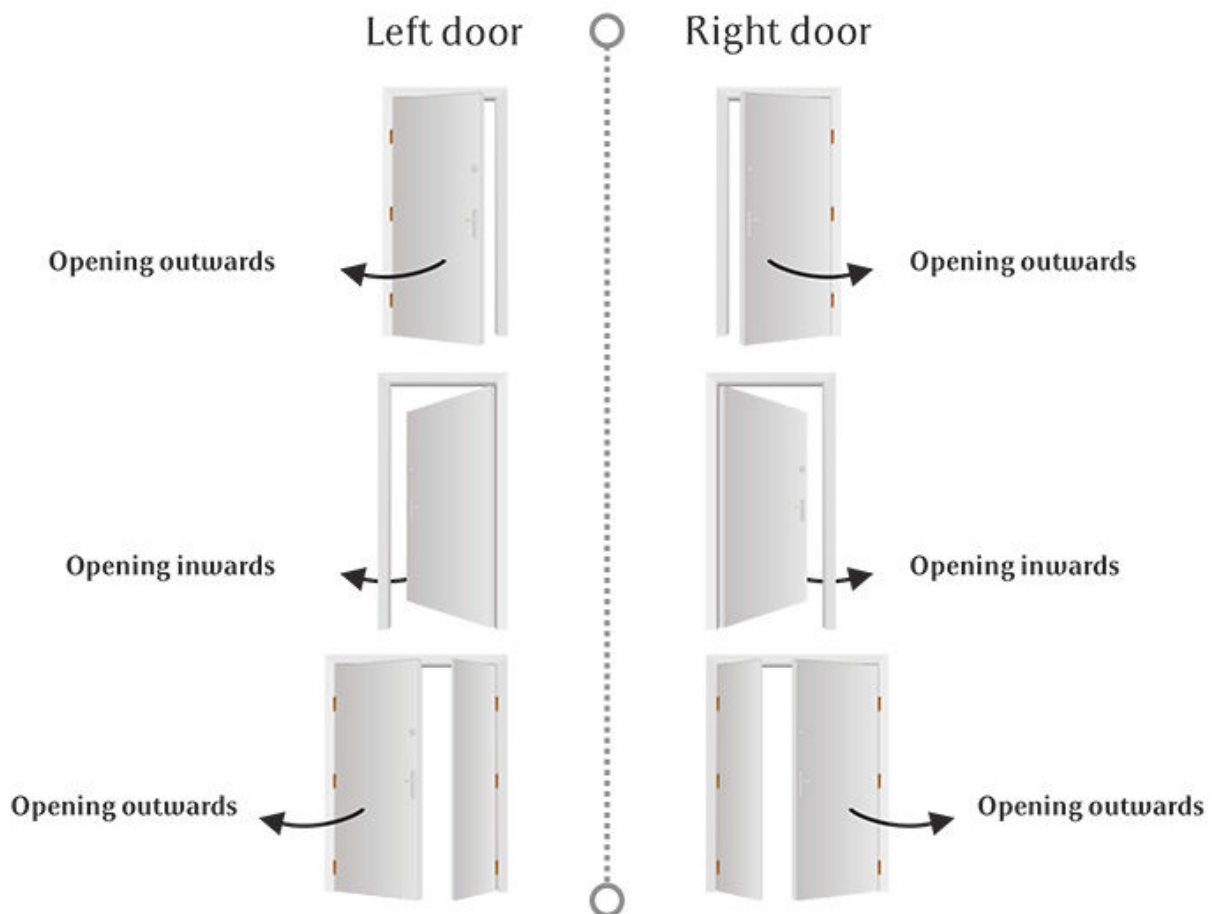

## Variants of sidelights - perfectly tailored to your needs

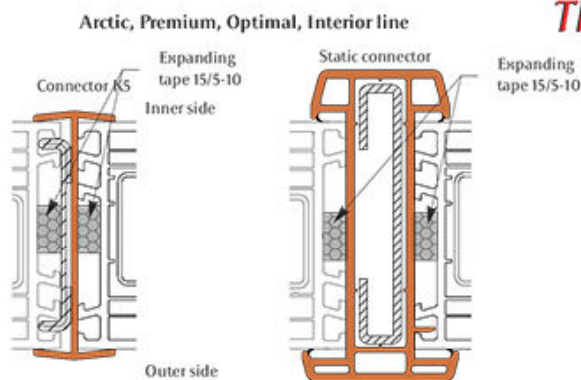
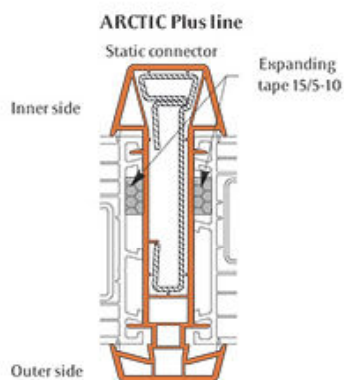
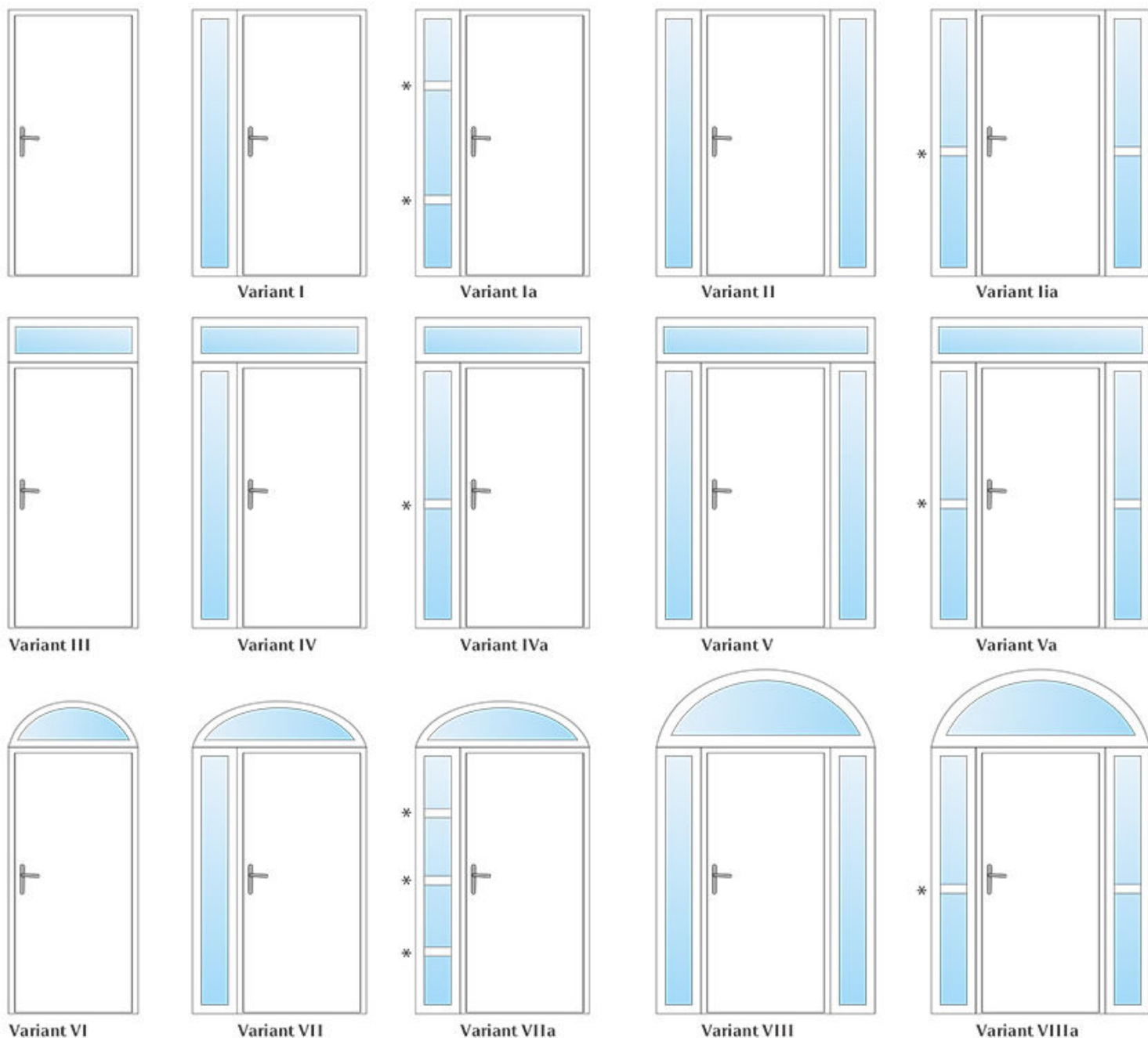

### The perfect combination

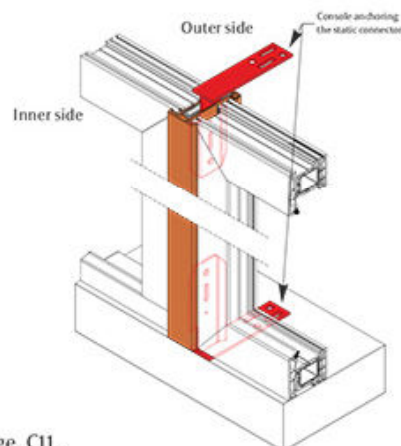

The sidelights of composite doors are manufactured in any variants, sizes and decorations.

\* Sidelight lacing. The number and configuration of the lacings according to the order - optional, see price list, page C11.

Types of sidelight fillings:

- ✓ triple glazed decorated glass unit in the design identical as stained glass of the sash,
- ✓ filling with composite panel of the structure and colors identical with the door sash.

Optional: composite panels filled with glazing unit in the design identical as stained glass of the sash - individual pricing.

If you expect different solution, please contact us: [wyceny@vikking.eu](mailto:wyceny@vikking.eu)

# Application variants of decorations and glass units



## Caption

- SMOOTH SMOOTH surface
- RW Real Wood surface (precious wood structure)
- F milled decoration of sash surface - one-sided
- FL flush stainless steel strip
- ~~FL~~ flush stainless steel strip - variant not available
- PL stainless steel finish strip
- LC stainless steel plinth strip (finish, height 90 mm)

- RZ flush stainless steel frame
- ~~RZ~~ flush stainless steel frame - variant not available
- RN stainless steel finish frame
- KZ external composite frame
- KW internal composite frame
- ZW the system on both sides frameless
- RR decorative frame of the classic collection

# Safety above all



1. All core and corps pins are steel hardened
2. Security mushroom pins as a protection against picking
3. Hardened steel pins in the corps to protect against drilling
4. Hardened steel pins in the core to protect against drilling
5. PROTECTOR - special active SV pin in the cylinder's cover: protection of key profile against unauthorized copying, protection of cylinder via an additional blocking element
6. Lateral valvular balls as additional blocking elements
7. Special protected key profile

1. Steel and brass core and corps pins are hardened with nickel coating
2. Security mushroom pins as a protection against picking
3. Hardened steel pins in the corps to protect against drilling
4. Hardened steel pins in the core to protect against drilling
5. Special protected key profile

1. Steel and brass core and corps pins are hardened with nickel coating
2. Security mushroom pins as a protection against picking
3. Hardened steel pins in the corps to protect against drilling
4. Hardened steel pins in the core to protect against drilling

1. Steel and brass core and corps pins are hardened with nickel coating
2. Security mushroom pins as a protection against picking

**WILKA**  
SCHLIESSTECHNIK

	Cylinder type	Category of use	Test cycles / durability	Door weight	Fire resistance	Security	Corrosion resistance	The security code	Resistance to attack	Burglar resistance
Classification according to EN 1303:2007	C PREM.	1	6	0	1	0	B	6	2	C
	C	1	6	0	1	0	B	6	2	C
	B	1	6	0	1	0	B	6	2	B
	A	1	6	0	1	0	B	6	0	A

## BioKey – Your biometric key

### Your fingerprint reader Your biometric key

The fingerprint reader provides security for you and your loved ones without the risk of loss or theft of the keys. Your (thumb / finger) is impossible to falsify.

Perfect solution for the household who often come in the house and go outside.

Put the registered finger to the reader and slide along the surface of the reader, and your door will open automatically.

When you cross the threshold - the door closer will immediately close the sash and the automatic lock will block it again. When you want you can open the door from the outside with use of the key and from the inside with use of the handle.

Ingeniously simple coding and change of the users do not need to use software or tools.

The fingerprint reader can be connected to the intelligent home system.

Forget about the keychain and slammed door. A fingerprint reader is comfort as well as the security of your loved ones. Allows for registration up to 150 users.



### Keyboard made of stainless steel

The keyboard is usually mounted in the sash. On the outside is visible the waterproof keypad made of stainless steel.

The controls are very simple, motor door lock is unlocked by entering any of the programmed code (4 to 8 digits). When you cross the threshold - the door closer will immediately close the sash and the automatic lock will block it again. When you want you can open the door from the outside with use of the key and from the inside with use of the handle.

The system can be programmed in a very friendly way with a considerable amount of codes, that can be allocated to any person and at any time can be change directly on the keyboard.

Excellent solution for public and multi-family buildings as the first barrier to access.

Biokey keyboard can be connected to the intelligent home system.



### Bluetooth

Control of lock in composite doors has never been so comfortable and easy.

Just use your phone with bluetooth application to get rid of the annoying keychain.

Bring your phone close up to the reader and touch your finger to the bluetooth panel - the automatic lock will immediately unlock the locking bolts.

When you cross the threshold - the door closer will immediately close the sash and the automatic lock will block it again.

When you want you can open the door from the outside with use of the key and from the inside with use of the handle.

Comfort within your multimedia phone.

Simple, intuitive application - and your doors are becoming more intelligent.

Biokey system allows you to program up to 6 devices and can be connected to the intelligent home system.





For your convenience and security in all doors in rebate version we use the highest-quality multi-point, anti-theft strip locks

**Three-point strip lock  
SECURY EUROPA MR2**

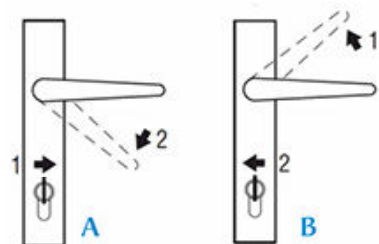
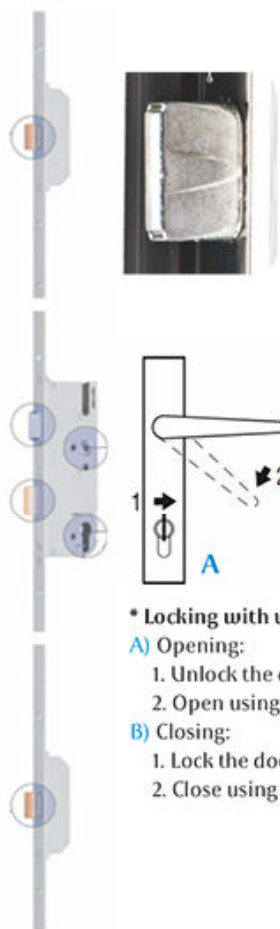

- \* Locking with use of door handle**
- A) Opening:**
1. Unlock the door lock using the key.
  2. Open using a door handle.
- B) Closing:**
1. Lock the door by lifting the handle up.
  2. Close using the key.

**Three-point strip lock  
SECURY AUTOMATIC**



**Four-point strip lock  
SECURY MR2 / 2PZ**



**Automatic three-point  
strip lock AV3**

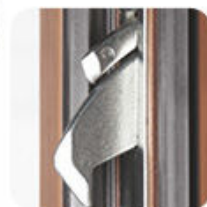

Automatic three-point strip lock AV3



day  
night



Door closer



Adjustable locking plate made of stainless steel



Burglary protection



nickel-satin (F9)

old gold (F4)

brown

white



Only in composite doors hinges are flush with the sash, are adjustable in three dimensions (3D), don't require maintenance, always in the color identical to fittings with no hidden surcharges for the covers.

**Highest Swiss quality!**



Pull handle P45 + door handle + door handle pla



Electric door strike with day/night function



Three-point strip lock, lockable by cylinder

Set of components dedicated to composite doors with one-sided pull handle and electric door strike or mechanical locking plate with day / night function.

# Door handles - branded, durable, safe



# Pull handles, accessories - perfectly composed



**Pull handle P45** + Lord door handle  
+ oval door handle plate



**Pull handle P45B** + Lord door handle  
+ oval door handle plate



**Pull handle Q45** + Baron door handle  
+ oval door handle plate



**Pull handle AXA Amsterdam**  
+ AXA Solo door handle  
+ AXA Solo door handle plate



**Microswitch**  
dedicated to AXA door handles

## WILKA cylinders



**INOX door holder**

**Straightened door holder**

## ABUS cylinders



**GEZE door closer**  
with rail



**GEZE door closer**  
with hold open arm  
(applies only to doors  
that open to the outside)



**Eye viewer** 16/200  
14/180

## AXA door stopper



+ stand 15 mm

+ stand 30 mm



inner side



outer side

**AXA DDS2 eye viewer**  
(integrated doorbell)



**AXA DDS1 eye viewer**

## ***We will take care of the nature and future generations***

Directive of the European Parliament dated 19.05.2010 on the energy performance of buildings requires that after 31/12/2020 all new buildings should be nearly zero-energy buildings.

**Passive buildings are the energy efficient buildings with the highest thermal comfort and extremely low energy demand for heating - less than 15 kWh/m<sup>2</sup>/year.**

Passive building is designed to use and keep inside the warmth deriving from the sun and renewables.

Do not wait until the last minute, save today!

**Arctic Plus composite doors with a vengeance meet the strict requirements of the passive house.**

**The idea of passive construction is very close to us.**

We actively support all activities to promote the improvement of energy efficiency, reduction of emissions of CO<sub>2</sub> and other harmful gases into the atmosphere.

Our share in the development of energy-efficient, airtight and durable composite doors has been confirmed by Polish Passive House Institute and Renewable Energy by granting us the title of **Ambassador of Passive Construction.**



## What you should know about installation of the front door?

The door mounted before the completion of all works is exposed to damage or destruction. In this case, until the works are completed we recommend the use of temporary technical doors.

**The door should be installed after the completion of all wet construction works, completion of target floor and bringing the humidity inside the building to a stable level below 60%.**

**Prior to installation, the wall within the door opening shall be prepared to the dimensions recommended by the manufacturer and the floor within the threshold section should have a channel required for the positioning of insulating PVC profiles.**

In principle (if the investor has not made other arrangements with the seller) these works are not included in standard door assembly service.

**Connection of door with the wall should be made in such a way, that it provides the total air tightness through a layer of frame insulation. Triple-layer warm assembly with the use of internal and external films increases the tightness with the wall by more than 70% compared to a conventional installation using polyurethane foam.**

**Composite entrance doors should be installed close to the outer layer of insulation in order to optimal use of their excellent protection against heat loss. The optimal solution is the location of the door frame in the way that it is partially covered by outer insulation wall.**

**Application of the method called triple-layer warm assembly eliminates thermal bridges and will contribute to the reduction of energy losses.**

**Traditional methods using mounting foam will not provide permanent protection against moisture and heat loss. Negligence in this regard can lead to costly, irreversible damage and to the growth of mold and mildew.**

To provide a stable positioning and protection against heat loss, the door should be firmly fixed on a PVC insulation profile with use of professional mounting components recommended by the manufacturer.

Equally important is the **proper execution of thermo-insulation and waterproofing within threshold section.**

For the isolation of subliminal part it is prohibited to use mounting foams, for this purpose should be done only **insulating expansion tape 15 / 5-12 or a flexible EPDM film.**

**NOTE:** Prohibited is to assembly the door with use of anchors used for PVC windows because of their limpness, not providing the stability of door frame profiles.

**All recommended components for correct installation, composite doors insulation and preservatives are available in the manufacturer's offer and its authorized distributors - see [www.vikking.eu/dealerzy](http://www.vikking.eu/dealerzy).**

Detailed conditions of door installation determine the manual attached to the product in the language of country of destination. Flagrant derogation from the rules of correct assembly of composite door may cause limitation or exclusion of manufacturer's warranty. Summarizing: **the door installation should be made by trained and authorized installers and in accordance with the manufacturer's instructions.**

Fulfillment of this requirement allows for full warranty protection and trouble-free operation of composite doors for many years.

**PLEASE REMEMBER! Professional installation is a very important link that affects the safety, comfort and operation of composite doors VIKKING.**



# Recommended installation system of composite doors

## Dedicated door assembly of Arctic Plus line

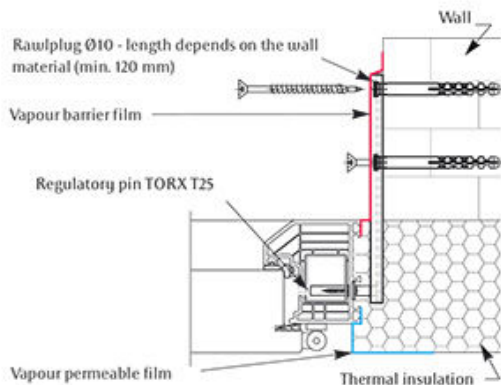

## Dedicated door assembly of Arctic, Premium, Optimal, Interior line

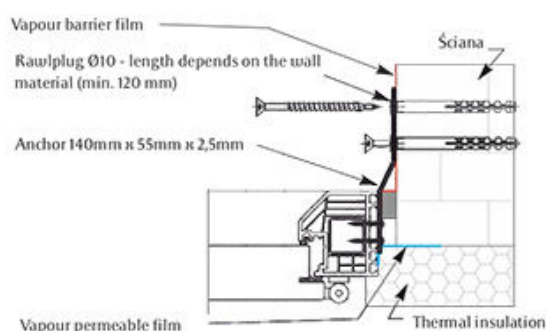

## Optimal anchorage points of doors and sidelights

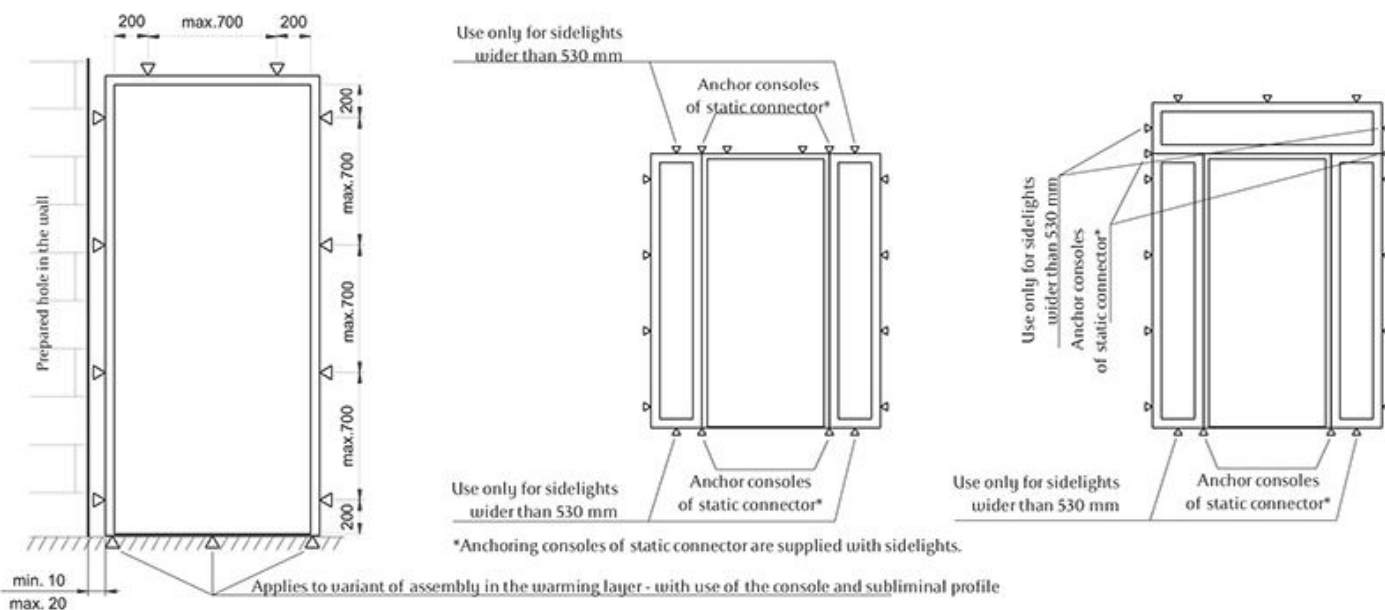

## Recommended positioning of a door on subliminal profile and insulation of threshold section

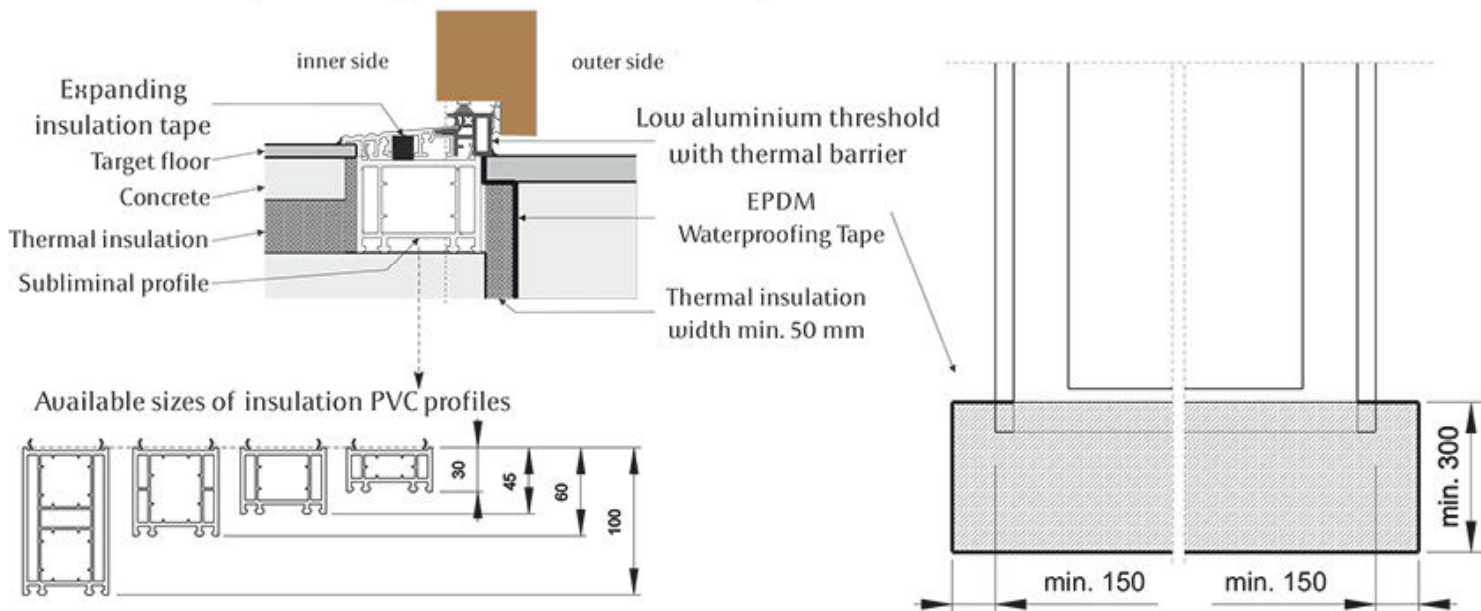

Detailed guidelines of composite doors assembly available for partners on: <http://strefa-partnera.vikking.eu>

# Hinge regulation instruction

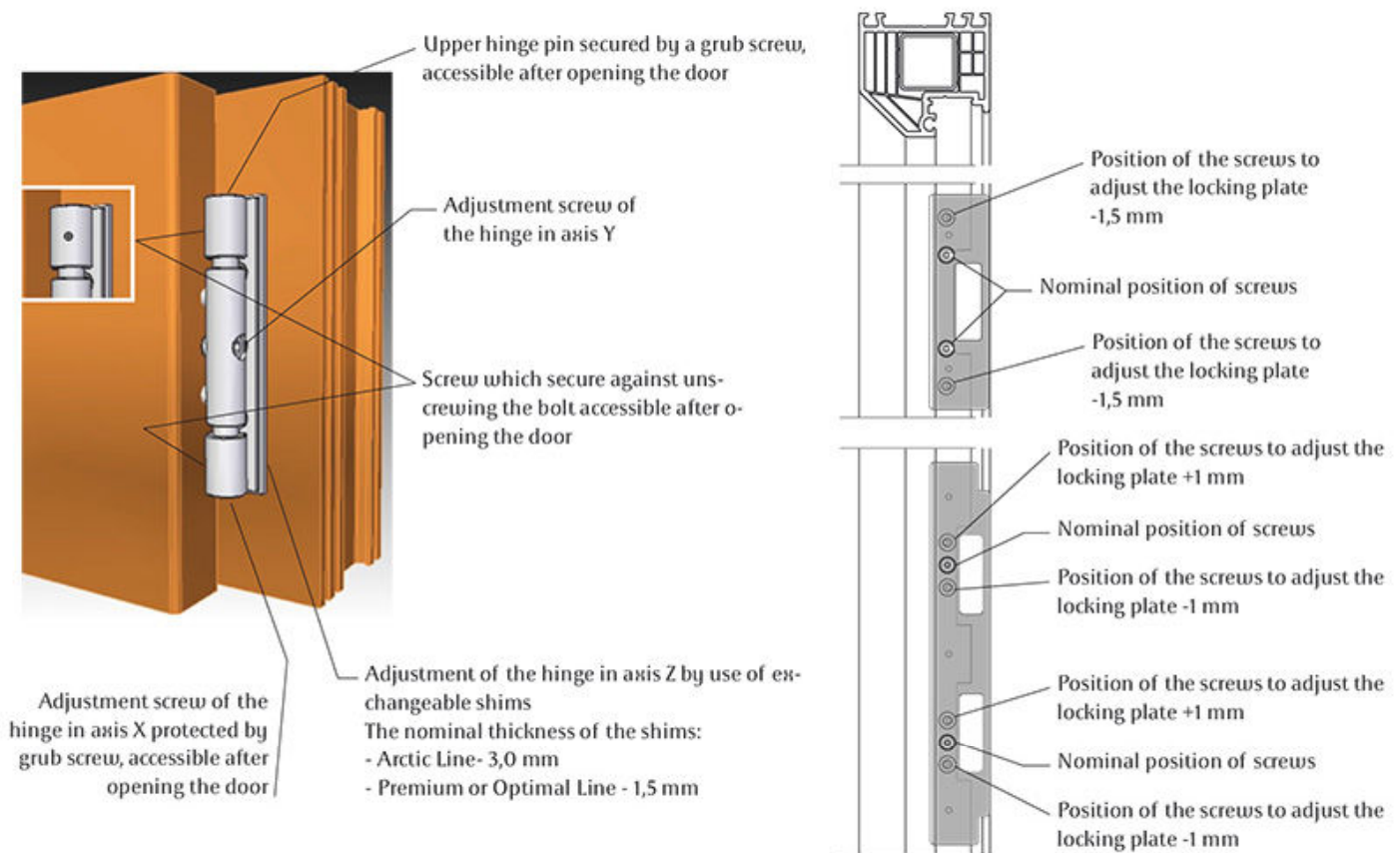

## Conditions of composite doors use

Composite doors, unlike traditional doors do not corrode, are resistant to moisture and difficult climatic conditions. Painting of the door is primarily made to improve their aesthetic properties; possible damage to coating does not affect the technical durability of composite doors and door frames.

However, to extend the period of trouble-free service of fittings, sealings and coatings - we recommend the use of roofings which protects the door from the UV.

During intense solar radiation, doors in white color heat up to 45°C. In similar conditions the surface of the door in dark colors may exceed 75°C. In extreme conditions, especially from the southern side, composite sash may temporary deform but after the cessation of the cause will return to its original state. In such locations we recommend the use of roofing which protects the door in dark colors against excessive heating or use the door from the ARCTIC or ARCTIC Plus line.

### Conditions of roofings:

ARCTIC PLUS line - optional;

ARCTIC line - optional;

PREMIUM line - required in dark colors of door installed on the southern wall of the building,

Lines: OPTIMAL; INTERIOR: mandatory.

Seals, fittings and moving parts of door, including the mechanisms of locks must be periodically checked and maintained according to the manufacturer's instructions - see: "Installation, use and maintenance of composite door" attached to the product.

Surfaces of glazings have coatings improving the protection against heat loss, for cleaning, use only agents exclusively dedicated to windows cleaning.

Elements made of stainless steel should not have prolonged contact with the standard steel, exhaust fumes and should not be used in areas with high salinity, such as in the vicinity of the sea. In these locations, we recommend the use of doors with composite frames.

Paint coatings of composite doors do not require maintenance; they should be periodically wiped with a damp microfiber cloth. Products from INOX should be periodically cleaned - their surface should be cleaned with use of preparations dedicated to stainless steel.

Dedicated preservatives are available at authorized points of sale.

**WE WISH YOU MANY YEARS OF TROUBLE-FREE USE OF COMPOSITE DOORS**

## Advantages of the system - notice the differences

If you are not sure, what you should pay attention to – compare the parameters of individual lines.

Pay particular attention to:

- ✓ **durability** confirmed by a written warranty of the manufacturer,
- ✓ **resistance** of doors to climatic conditions - especially moisture,
- ✓ **the insulation efficiency** expressed by Ud factor - the lower the value, the greater the protection against the loss of valuable energy,
- ✓ **anti-theft security** according to one applicable European standard RC 2
- ✓ available dimensions of doors and sidelights,
- ✓ equipment, coloring and stained glass decorations,

If you are still not convinced - personally compare parameters, durability and price of our door with any offer from another manufacturer.

Name		ARCTIC Plus	ARCTIC	PREMIUM	OPTIMAL	INTERIOR	X
Thermal insulation - W/m <sup>2</sup> K		from 0,63 to 0,79	from 0,8 to 0,85	from 0,85 to 1,0	from 0,85 to 1,0	od 1,0 do 1,1	
Resistance to burglary class RC 2		S*	S*	S*	O	O	
The requirement of full roofing		N/D	N/D	O**	W	W	
Warranty	Sash	25 years	25 years	20 years	15 years	15 lat	
	PVC door frame	10 years	10 years	10 years	10 years	10 lat	
	Paint coatings	5 years	5 years	5 years	5 years	5 lat	
	Other components	3 years	3 years	3 years	3 years	3 lata	
PVC door frame – 6-chamber class A+		S	S	S	S	S	
Meranti door frame		O	O	O	N/D	N/D	
Composite sash		68 mm	60 mm	45 mm	45 mm	45 mm	
SMOOTH door surface		O	O	O	N/D	N/D	
Real Wood door surface (grain wood)		S	S	S	S	S	
Doors in size XXL	max 1095 mm x 2210 mm	S	N/D	N/D	N/D	N/D	
	max 1085 mm x 2200 mm	O	S	S	N/D	N/D	
The possibility of shortening and narrowing of the door		O	O	O	O	O	
Sidelights, top lights and doors according to individual projects		O	O	O	N/D	O	
Number of seals		3	2	2	2	3	
Low aluminum threshold with thermal barrier		S	S	S	S	S	
3D adjustable hinges in color of the fittings with a set of security bolts		S	S	S	S	S	
3-point strip lock lockable by door handle		S	S	S	S	O	
3-point strip lock Automatic		S	S	O	N/D	N/D	
4-point strip lock lockable by cylinder		O	O	O	O	O	
Adjustable locking plates made of stainless steel		S	S	S	S	S	
Painting in full range of RAL colors		S	S	S	S	S	
Painting in wood grain decors		S	S	S	O	O	
Multi-colored painting		O	O	O	N/D	O	
Triple glazed stained glass units with warm edge Super Spacer		N/D	S	S	O	O	
Quadruple glazing units with warm edge Super Spacer		S	N/D	N/D	N/D	N/D	

S - standard

O - optional

W - required

N/D - not applicable

\*applies to full doors with security cylinders and door handles

\*\*recommended in the case of painting the doors in dark colors

**X - Insert parameters of other doors and compare with offer of composite doors**



### **Brand - guarantee of the promise fulfilment**

"VIKING Composite Doors" is a guarantee of the highest quality for generations

We have created from scratch innovative composite doors of the highest quality and durability.

Regardless of the statutory requirements of consumer protection in the form of warranty for faults and liability for non-conformity of the product with the agreement - we take the challenge of granting the extended warranty for trouble-free operation:

<b>25 years</b>	- Composite sashes - ARCTIC PLUS and ARCTIC lines
<b>20 years</b>	- Composite sashes - PREMIUM line
<b>15 years</b>	- Composite sashes - OPTIMAL and INTERIOR lines
<b>10 years</b>	- PVC door frames, hinges and locking plates
<b>5 years</b>	- Paint coatings and stained glass units
<b>3 years</b>	- Stripe locks and technical efficiency of other components

Ensuring the technical functioning is conditioned by:

- I - correct, adequate to operating conditions selection of doors lines and its equipment
- II - the use of composite door in accordance with its intended use
- III - the correct installation of the door by authorized installers with use of warm assembly according to the manufacturer's guidelines
- IV - making periodic checks, adjustments and maintenance according to the manufacturer's guidelines
- V - immediate removal of possible faults, that will protect against further damage of the door
- VI - the use the door in the segment of individual housing construction, for other applications, apply the standard 3-year warranty

*The full content of the guarantee and guidance on quality acceptance, correct installation, operation and maintenance we attach to each product in the language of country of destination.*

***We provide warranty and post-warranty service.***



